

LPKF TechGuide
In-House PCB Prototyping

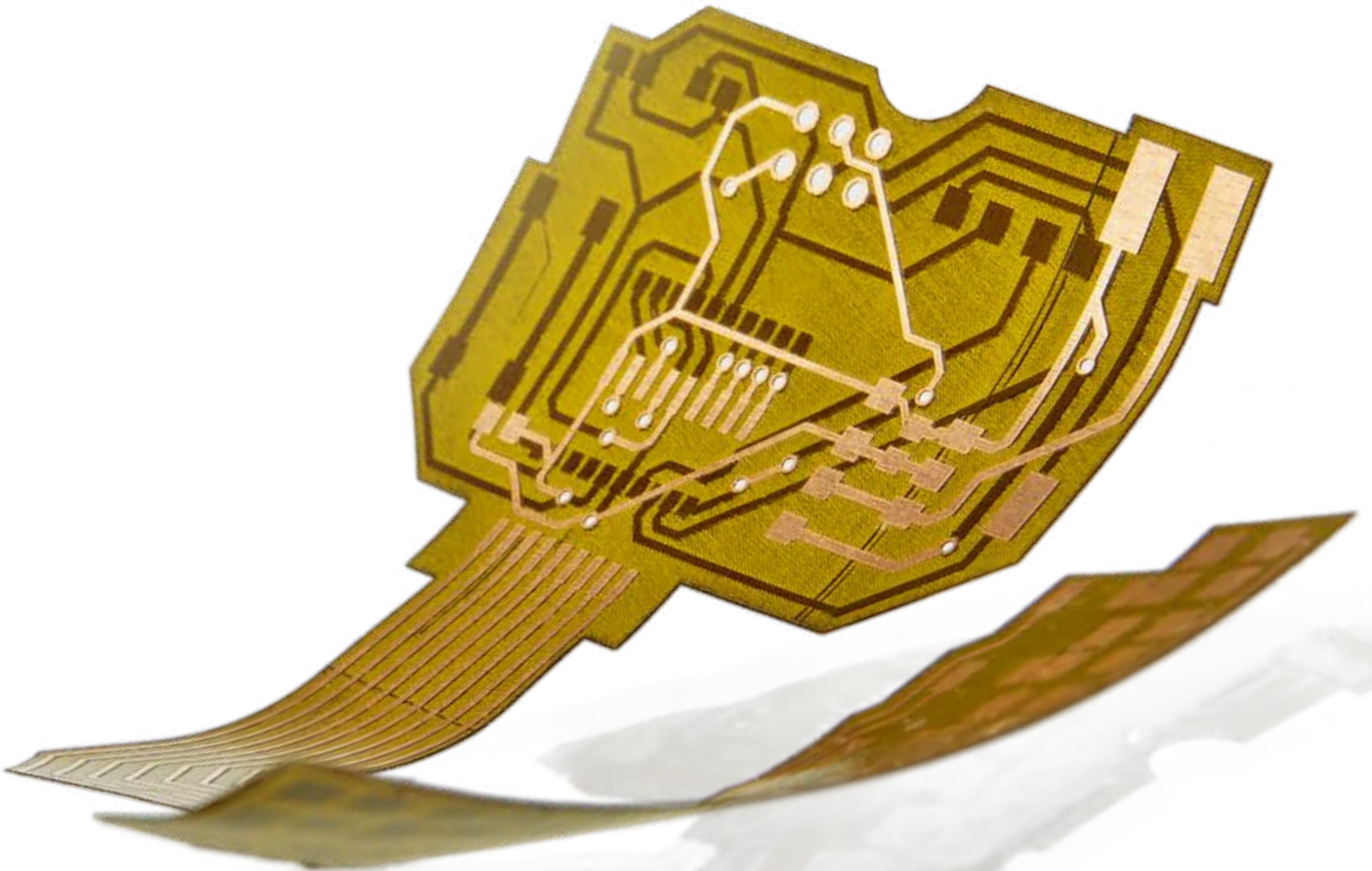

Do you have any Questions about your Order? Do you Require Technical Support?

You can find all sales and service contact information below.

Our experienced employees will be happy to assist you.

LPKF Sales and Service

Germany (LPKF Headquarters)

Phone +49 (5131) 7095-0
Fax +49 (5131) 7095-90

E-Mail sales.rp@lpkf.com
support.rp@lpkf.com

Website www.lpkf.com

North/Central America

Phone +1 (503) 454-4200
Fax +1 (503) 682-7151

E-Mail sales@lpkfusa.com
support@lpkfusa.com

Website www.lpkfusa.com

China

Phone
Sales +86 (22) 2378-5318
Service +86 (22) 2378-5328

E-Mail sales.china@lpkf.com

Website www.lpkf.com

Japan

Phone +81 47 432-5100
Fax +81 47 432-5104

E-Mail info.japan@lpkf.com

Website www.lpkf.com

South Korea

Phone +82 (31) 689 3660
Fax +82 (31) 478 5988

E-Mail sales.korea@lpkf.com

Website www.lpkf.com

Worldwide LPKF Representatives

LPKF AG has a global sales network. An overview of all LPKF representatives can be found on page 36.

For more information, please visit our website at www.lpkf.com.



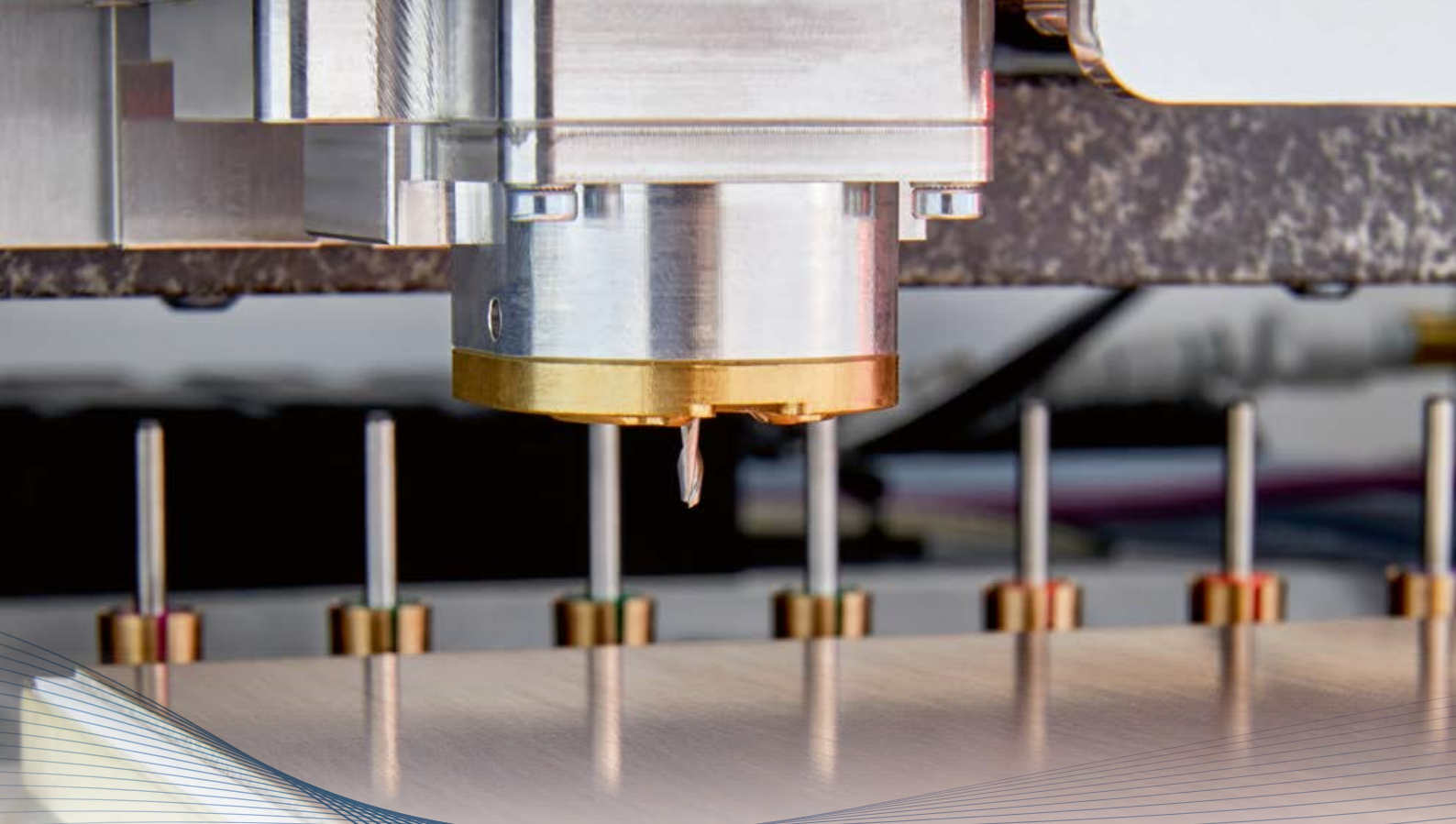

TechGuide

This TechGuide provides a practice-oriented overview of LPKF's innovative prototyping solutions with numerous application examples and explanations. With an exhaustive range of prototyping methods, PCB production prototypes can be made in-house.

Go from design to finished prototype in a few hours without any design data leaving the company and also carry out in-house production of small batches "on demand" – all this is possible with LPKF processes. LPKF prototyping means reliable results and production prototypes in the shortest time with minimal impact on the environment.

The technical information contained in this guide is intended to supplement the LPKF product catalog. This guide does not take the place of the manuals provided with the individual products. Always heed the safety instructions and the legal requirements.

i Specifications and process sequences are provided for illustrative purposes only and are subject to change without notice.

Contents	
PCB Prototyping Process Steps	2
Surface Mounted Technology (SMT)	3
Basic Information on PCBs	4
LPKF Software	6
PCB Structuring and Processing	8
Laser Micro Material Processing	10
PCB Structuring with the LPKF ProtoLaser S4	12
A Universal Tool: The LPKF ProtoLaser U4	14
PCB Structuring with the LPKF ProtoMat D104	16
Multilayer Manufacturing and Lamination	18
Center Punching, Drilling, and Producing Cutouts	20
Through-Hole Plating Systems	21
Comparison of Through-Hole Plating Methods	24
Solder Masks and Legend Printing	25
Solder Paste Printing	26
SMD Assembly	27
Reflow Soldering	28
Applications	29
Technical Terms	32
LPKF International Contacts	36
Legal Information	37

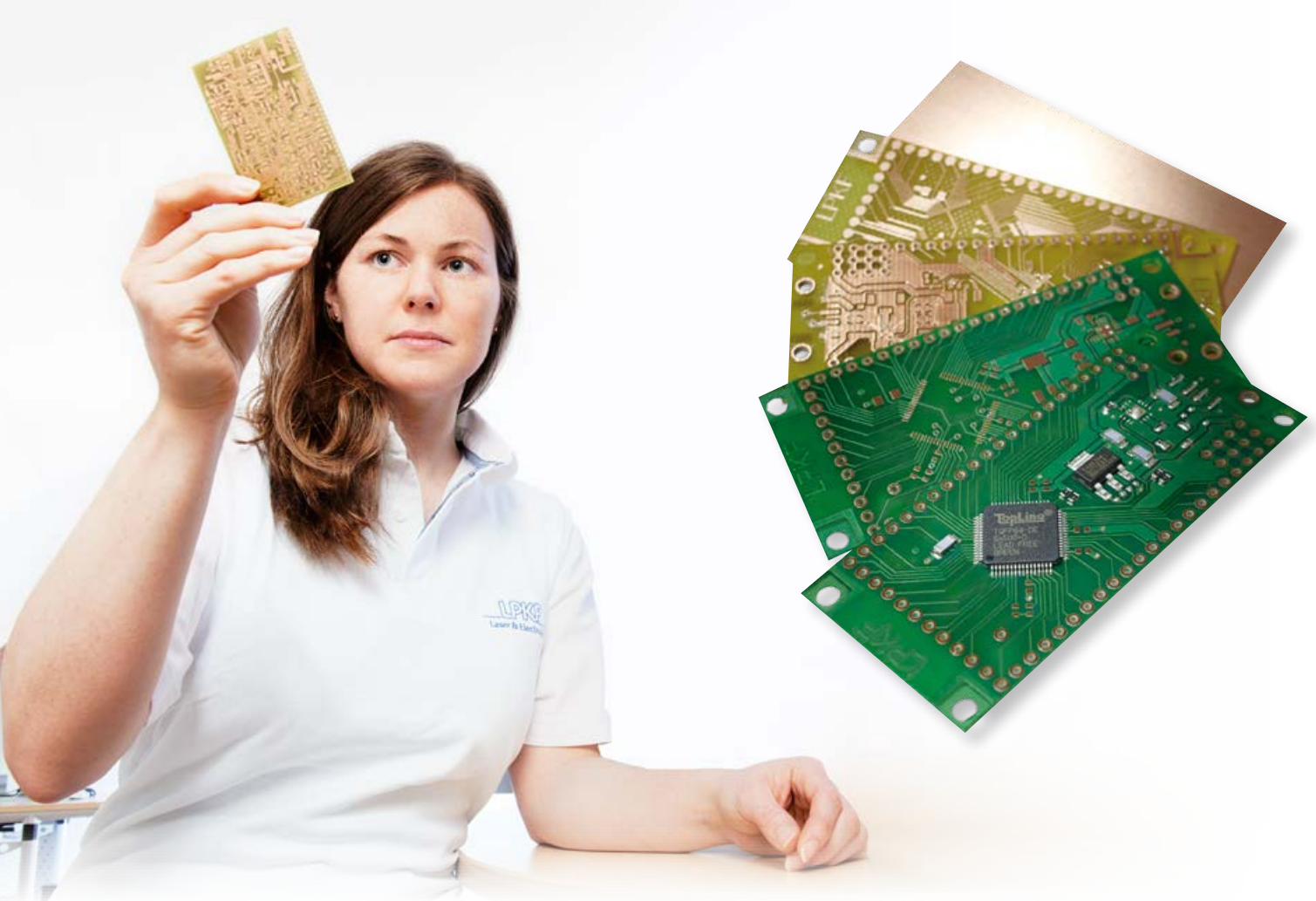

PCB Prototyping Process Steps

From idea to finished product – LPKF provides all the necessary equipment to turn your design into a functioning prototype. In the first step, a circuit board plotter or a laser system isolates the conductive traces on a base material. Additional processing steps quickly lead to a completed printed circuit board.

PCB Structuring

The LPKF ProtoMat series circuit board plotters are the worldwide standard in precision, flexibility, and ease of operation. The ProtoMat mills the structure of the printed circuit board out of a fully coated substrate. The LPKF circuit board plotters significantly reduce manufacturing times for PCB prototypes and shorten development lead times for new products. High-speed spindles with speeds ranging from 30 000 to 100 000 RPM, mechanical resolution of up to 0.25 μm (0.01 mil), and an extremely high repeatability ensure that the finest structures can be reliably produced even for RF and microwave applications. The ProtoMat systems can also drill the holes for double-sided and

multilayer PCBs and plug-in assembly of electronic components.

LPKF ProtoLaser systems have set a new benchmark of precision: the ProtoLasers offer non-contact structuring with no tools and are already preconfigured for numerous substrates and conductive coatings. With their special capabilities for RF boards and ceramic materials, LPKF ProtoLaser systems are unsurpassed.

The two worlds come together in the LPKF ProtoMat D104: mechanical structuring is supplemented with an additional laser tool for areas requiring especially high precision and small features.

Surface Mounted Technology (SMT)

SMT is a design principle in which tiny electronic components are applied directly onto a PCB. These components are SMDs (surface-mounted devices), i. e., surface-mountable elements. SMT prototyping encompasses solder paste printing as well as SMD assembly.

In-house SMT prototyping saves time and helps ensure that your data remains secure in your own facility and not exposed to third parties. LPKF equipment provides the precision necessary for a coordinated SMT prototyping system.

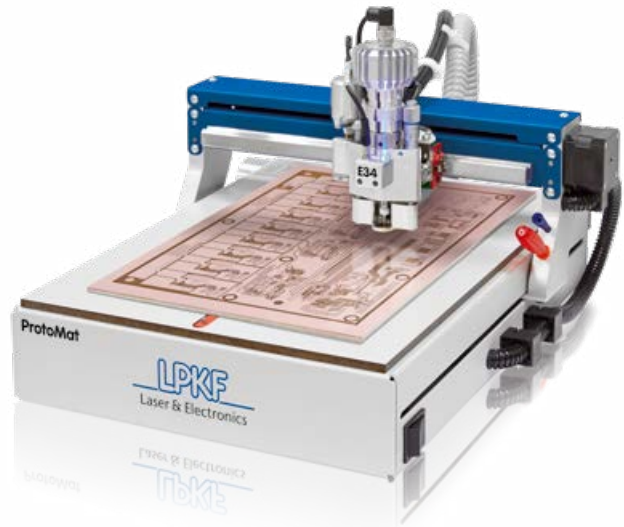

Drilling and Through-Hole Plating

One process step is the through-hole plating of the boards. A ProtoMat or a ProtoLaser drills holes in double-sided PCBs or multilayers. Through-hole plating can be performed by electroplating with a conductive paste, or using riveting technology depending on the application area for the PCBs. LPKF offers professional systems for all these methods.

Multilayers

Even complete multilayer circuits can be produced within a short period with professional results. The LPKF MultiPress S provides developers with a state-of-the-art multilayer lamination press for in-house production.

Singulate/Depanel PCBs

Depaneling the PCBs from the base material is another task performed by the LPKF ProtoMats. One or more boards are arranged on a base material and singulated with a milling tool or an LPKF ProtoLaser.

Solder Masks

The use of solder masks is often essential in SMT assemblies. Applying a solder mask to the board prevents subsequent short-circuiting and corrosion. LPKF ProMask is an easy-to-use solution for protective mask application.

Legend Printing

LPKF also offers an ecological and easy-to-use solution for labeling the PCB with the components or the manufacturer's logo with LPKF ProLegend.

Solder Paste Stencils

An SMD solder paste is applied onto all pads to be mounted using a solder paste stencil. Prototyping stencils can be produced with an LPKF ProtoMat or laser system. They are then printed using a special stencil printer such as the LPKF ProtoPrint S.

SMD Assembly

Mounting of SMD components on the PCB requires high accuracy. Therefore, a semi-automatic assembly system such as the LPKF ProtoPlace S is used for PCB prototyping, where the exact placement of the elements is monitored via a camera system.

Reflow Soldering

The last production step in SMT prototyping is reflow soldering. LPKF ProtoFlow reflow ovens heat solder paste with predefined and customizable temperature profiles. Once the solder paste is cured, the components are connected and the board is finished.

Basic Information on PCBs

The PCB not only mechanically supports the electronic components but also electrically connects them through a network of conductive traces, provides shielding against electromagnetic interference (EMI), and enables heat dissipation. In an increasingly complex process, more and more conductive traces and components have to be placed in the same space. Prototyping offers various technical solutions for this.

Single-Sided PCBs

The base material in a single-sided PCB consists of an electrically insulating substrate that is coated with a conductive material. FR4 (fiberglass-reinforced epoxy resin) substrates are the most common, and copper is typically used for the conductive layer. The copper layer is given as the copper thickness in micrometers (μm) or the copper weight in ounces per square foot (oz). The typical layer thickness is $35\ \mu\text{m}$ (1 oz). In some cases, the copper is coated with an additional metal such as nickel, tin, or gold (surface finish). The FR4 substrate thickness varies between 0.25 mm (10 mil) and 3.125 mm (125 mil), and the most frequently occurring base material thickness is 0.8 mm (29 mil) or 1.6 mm (59 mil).

Double-Sided PCBs

For double-sided PCBs, both the top surface and the bottom surface are coated with a conductive material (usually copper). LPKF circuit board plotters feature mechanical fiducial systems or cameras for automatic position detection to assist in drilling and milling of double-sided PCBs. This ensures that the structures on both sides of the board are matching. Every ProtoLaser system comes with a vacuum table and a fiducial alignment camera as standard features.

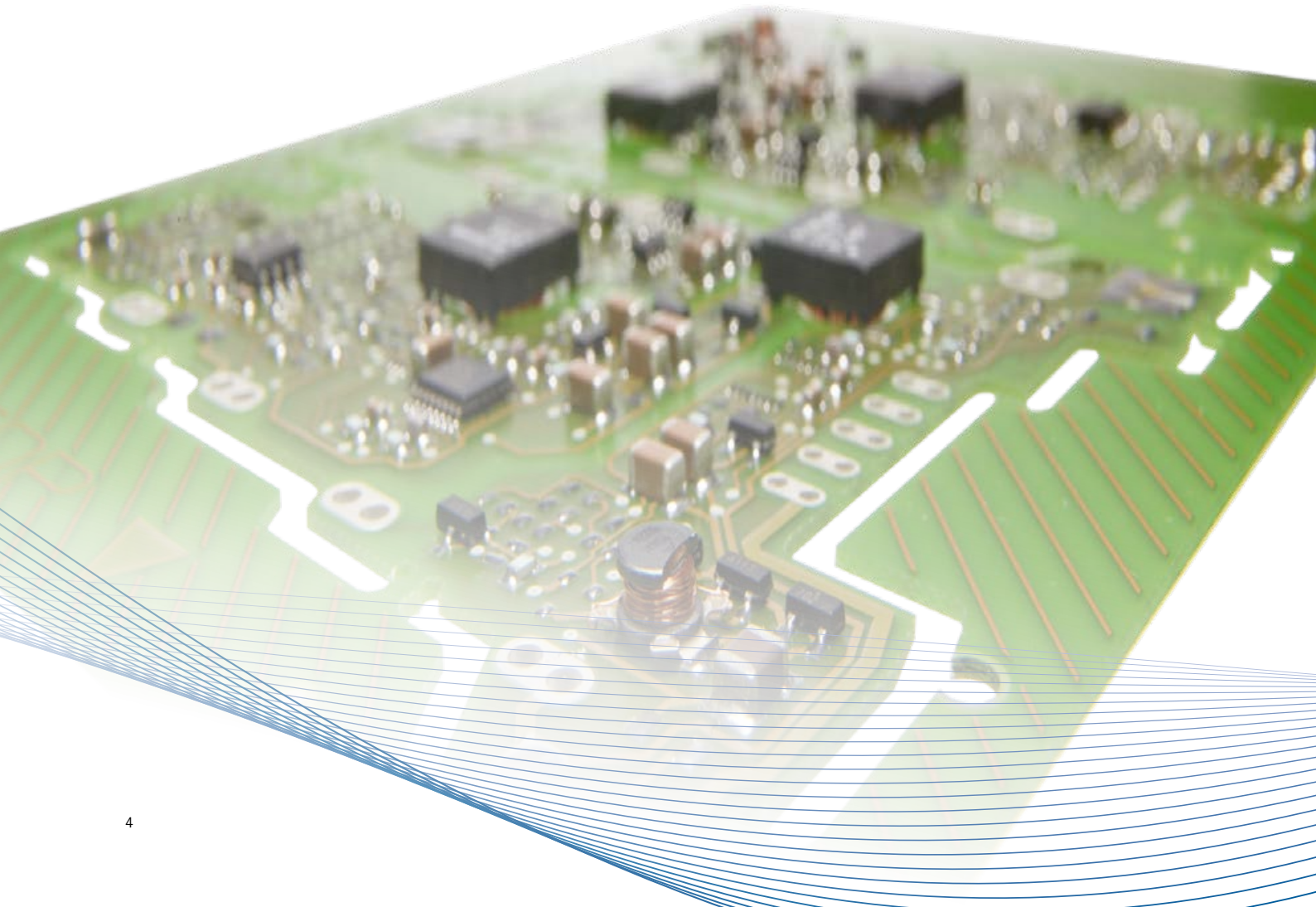

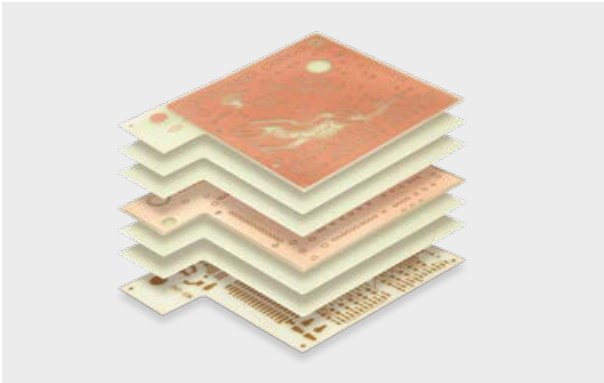

Multilayer

Multilayers

The LPKF ProtoMat and ProtoLaser models allow for rapid multilayer development. Multilayer PCBs can be made up of double-sided internal layers and single-sided material as external layers. For electrical interconnection of layers, a through-hole plating method required.

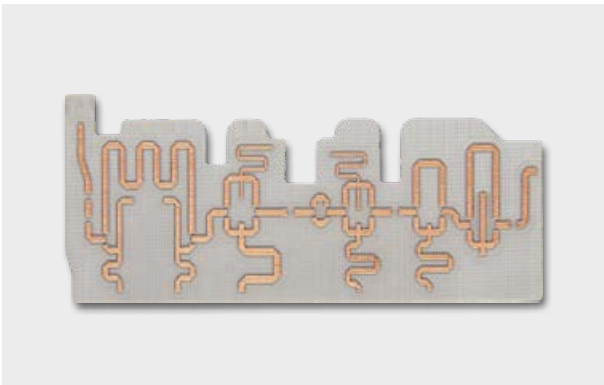

TMM substrate and PTFE substrate

RF and Microwave Circuits

RF and microwave circuit boards consist of materials with special electrical and mechanical properties such as fiberglass-reinforced polymer resin. With RO4000®, ceramic particles are also included.

Processing of these often extremely delicate surfaces and the exact geometries require maximum precision: ProtoMat plotters with high spindle speeds or ProtoLasers ensure the precise agreement between design/simulation and structuring results.

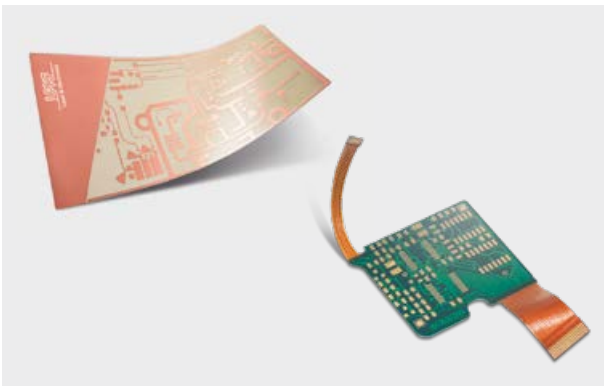

Flex and rigid-flex substrates

Flex and Rigid-Flex PCBs

Flexible PCBs are usually made of polyimide films with copper traces. Rigid-flex PCBs are formed through the combination of flexible substrates and rigid PCBs. The fabrication process for rigid-flex PCBs is similar to that used for multilayers. Laser etching of metal is also possible on various flex substrates with the ProtoLaser models.

LPKF Software – Smart Prototyping Assistant

Precision counts – LPKF CircuitPro software is the latest generation of powerful CAM and machine software. It combines data preparation and system control in one program and is developed in-house by LPKF.

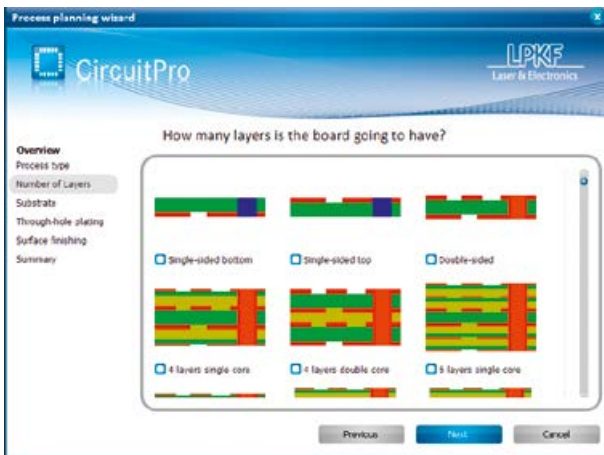

During installation LPKF CircuitPro software can adapt process steps based on the prototyping units available and includes them in the production process. LPKF CircuitPro imports design data from CAD/EDA systems. The Process Planning wizard prompts the user to enter information such as the number of layers, the material used, and further processing requirements. The software makes PCB creation simple with clear step-by-step procedures.

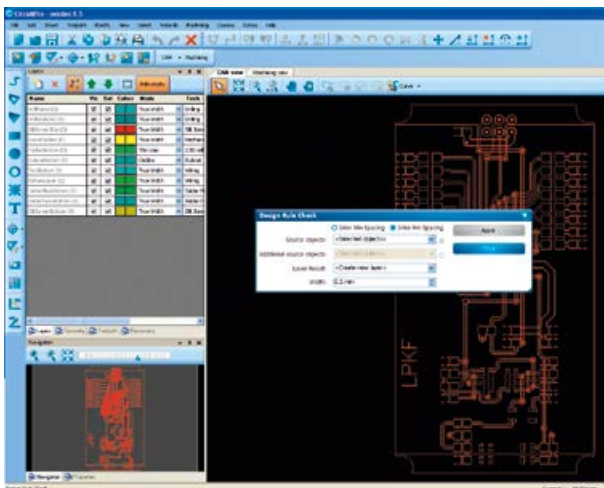

The LPKF CircuitPro software includes advanced algorithms for mechanical milling or laser paths for design processing. A design rule check is also available to verify spacing that can be processed with the available tools.

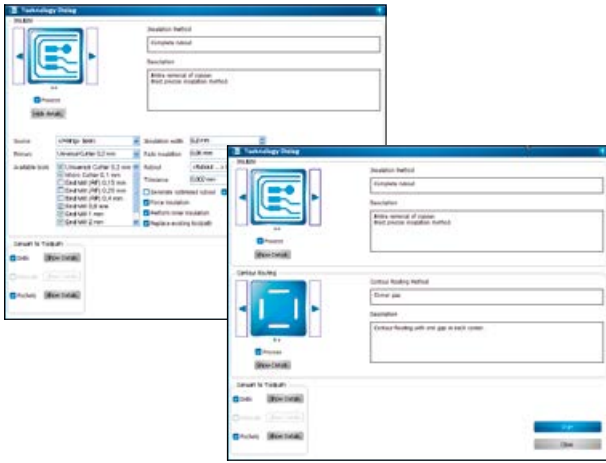

In the next step LPKF CircuitPro generates milling lines for insulating the conductive traces and the contours for depaneling of the board – both in the technology dialog box. You can also customize your board with options for isolation, rub-out and break-out tabs.

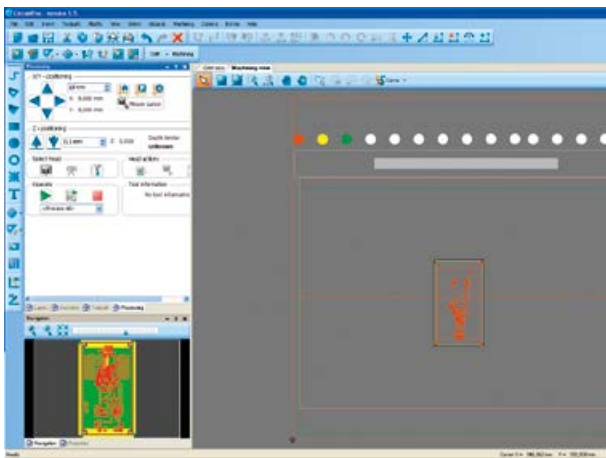

Further control of the project is assumed by the production wizard, which guides the user through the production process. After the view has switched from CAM to machine view, LPKF CircuitPro prompts the user to enter the material properties and defines the position on the working surface.

The project is then displayed on the virtual working surface – and production can then begin. At this point multiple PCBs from a project can be positioned on a panel. The PCBs are all fabricated from the same base material.

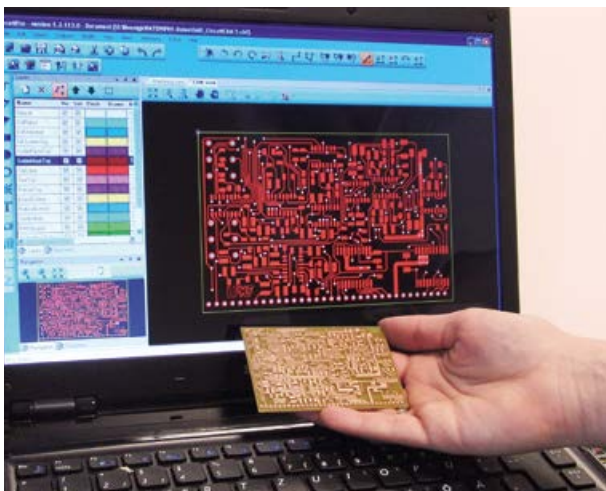

During the processing of the board the wizard prompts the user when manual intervention is necessary. These interventions can include turning over of the processed board, through-hole plating, or changing a tool. If the project is saved at the end, all production data will be immediately available for the next run.

Detection of geometric structures has been enhanced in the latest version. This allows the ProtoMats and ProtoLasers to significantly accelerate the work process.

PCB Structuring and Processing

After the circuit has been designed, the included LPKF CircuitPro software allows importing of the planned trace layout. Depending on the design and material requirements, one of two different processing methods established by LPKF for PCB development can be selected: mechanical structuring by milling with various ProtoMat systems or laser structuring with ProtoLaser models.

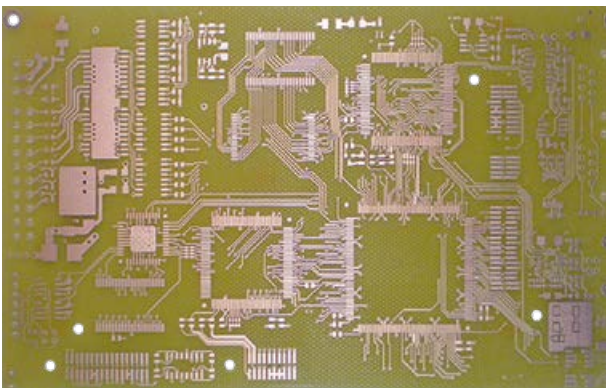

Single- and double-sided PCBs and multilayers

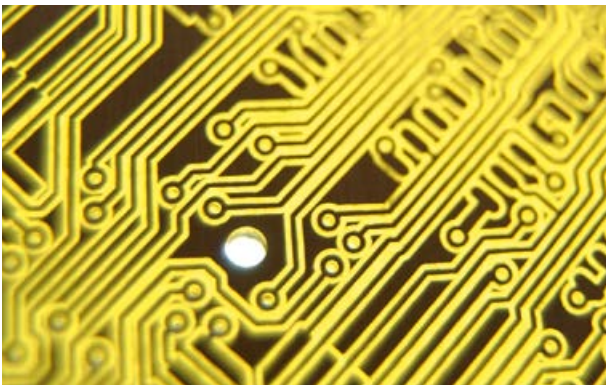

Conductive patterns created by milling contours

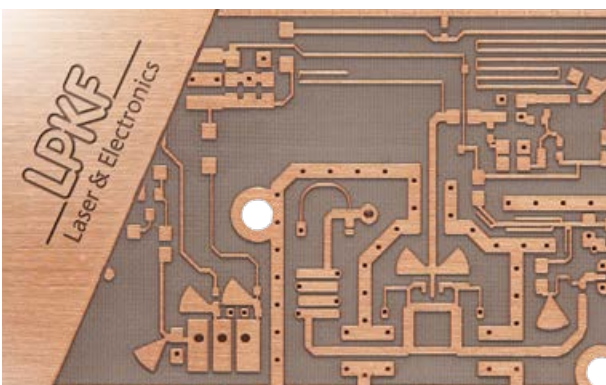

Interconnect device for RF and microwave technologies

Generating Conductive Patterns by Mechanical Milling

The milling process transfers the PCB layout of the outer and inner layers onto the base material. The conductive material is thereby removed from the insulating layer by a high-speed spindle and milling tools.

The higher the speed, the finer the tools that can be used for milling. This is especially beneficial for base materials for RF applications. The spindle motors provide low runout allow for the finest traces and spacing.

All traces and solder pads are isolated with the standard milling tool. This guarantees both clean and consistent edge geometries, which positively affects the electrical properties of a PCB. Smaller milling tools are used only in places with smaller spacings. Rubout areas are automatically milled with the largest possible milling tool.

Some milling tools for structuring PCBs have conical tips. At the beginning of the milling process, the milling width is set via the depth of penetration into the base material (milling depth).

Various methods can be used for the milling width adjustment: if automated tool change is installed, the drilling and milling tools are automatically changed during the fabrication process. The tool change is combined with an automatic milling width adjustment. For a manual tool change, the milling depth is adjusted with a micrometer screw.

The exchange is controlled via the LPKF CircuitPro system software. The service life of the various tools is stored in the control software. A warning message indicates when a pending tool change is needed. The acoustic cabinet on the LPKF circuit board plotter minimizes noise emissions and ensures optimal occupational safety in any working environment.

Laser Structuring

The laser offers the best conditions for direct structuring of copper-plated PCBs. High precision and edge accuracy especially qualify the laser process for structuring of RF layouts. Laser micro processing features high energy densities on the smallest area, excellent focusing capabilities, and control of the laser settings.

Because the layers in composite materials have different ablation thresholds, the patented process of targeted delamination is used in laser structuring. The laser beam first creates the trace structure on the surface of the PCB with a precisely dosed energy input.



LPKF ProtoLaser S4

Then it systematically delaminates the conductive layer – typically copper – with a lower energy to prevent damage to the substrate. This patented process allows the laser to be used for direct structuring of PCBs with an ablation rate of up to 9 cm²/min. Because this has minimal impact on the substrate material, the measured insulation resistances meet the requirements of IPC standard TM 650.

In the structuring of pure ceramic interconnect devices, the conductive metal layers are vaporized through the high laser energy, not ablated. Laser etching can achieve insulation spacings as small as 15 µm. For drilling and depaneling of multilayer PCBs, an LPKF ProtoMat is recommended. The new ProtoLaser U4 can perform both tasks: it structures laminated substrates and then cuts them out of larger boards.

The LPKF ProtoMat D104 combines a mechanical machining system with a laser. The laser works solely as a vaporizing tool and is only used in extremely fine regions. However, the mechanical operations can also drill, engrave, and depanel boards – making it an ideal combination of both machine types.

Powerful Machine Software

The LPKF CircuitPro CAM software is the basis for easy operation of the LPKF ProtoMats and ProtoLasers. It converts the designs from common layout programs into control data for the structuring systems, allows optimization of layout elements to be performed, and offers design rule verifications.

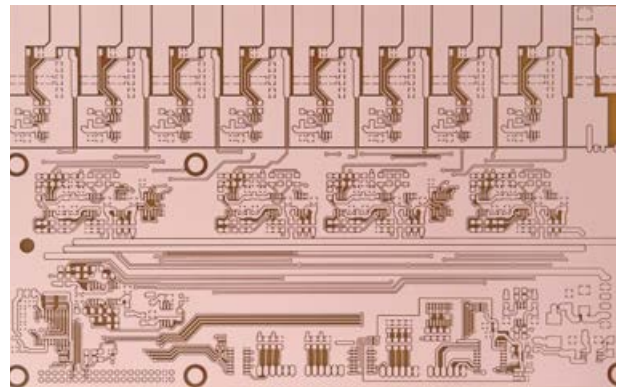

FR4 PCB structured with a ProtoLaser S4

This enables any user to create individual PCBs and small batches with ease. LPKF systems are ideal for high-performance, analog, digital, RF, and microwave applications. Options such as a vacuum table or the vision system further simplify handling and reduce the required user intervention to a minimum.

Laser Micro Material Processing

Laser light differs from conventional light in several fundamental ways. Laser light is monochromatic; it exhibits a low spread of frequencies. At the same time, the high amounts of energy are concentrated in an active area closely bound by the beam diameter. LPKF software allows for adjustment of laser settings for various PCB development and research applications.

The laser wavelength differs according to the emitting laser source – this is a key aspect in the broad applicability. Different materials have different absorption properties. The higher the absorption of a material, the greater the amount of energy transferred by the laser. LPKF offers several ProtoLaser models for PCB development.

The incoming laser light interacts with the material in three ways:

- Transmission – the part of the laser light passing through the material
- Reflection – the part of the laser light reflected by the material
- Absorption – the laser light that affects the target material

The laser transfers energy to the material without touching it. The absorbed energy excites electrons in the target material. This has three different effects:

- Chemical bonds are broken by the input energy.
- The material melts due to the energy input.
- High pulse energies evaporate the material.

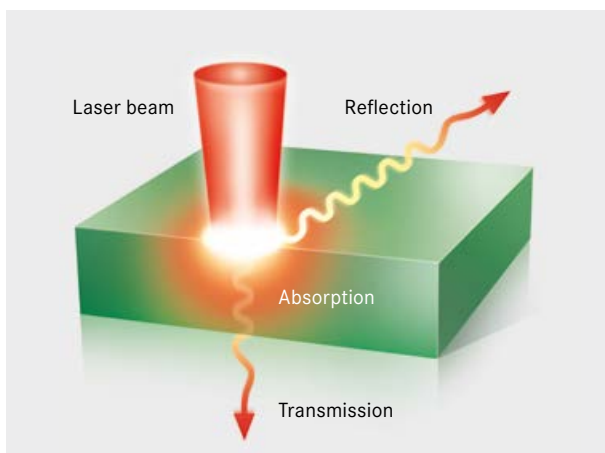

Only the absorbed energy has an effect on the part

Rapid laser etching with LPKF patented processing and operator adjustable settings makes the process cost-effective, fast, and robust.

Laser micro material processing is one of the core competencies at LPKF. The ProtoLaser models cut, drill, and structure thin multilayers, rigid, rigid-flex, and flex PCBs. They are extremely precise, nondamaging, and fast. Engraving, scoring, and labeling were some of the typical applications for first-generation laser systems. The application range has expanded over the years and now includes, e.g., invisible microstructured layouts on films and glass substrates for touch screens.

Microprocessing of ceramics is a primary capability of the ProtoLaser models. The lasers can be used for direct structuring through evaporation of a conductive coating and for precise cutting/scoring of the material.

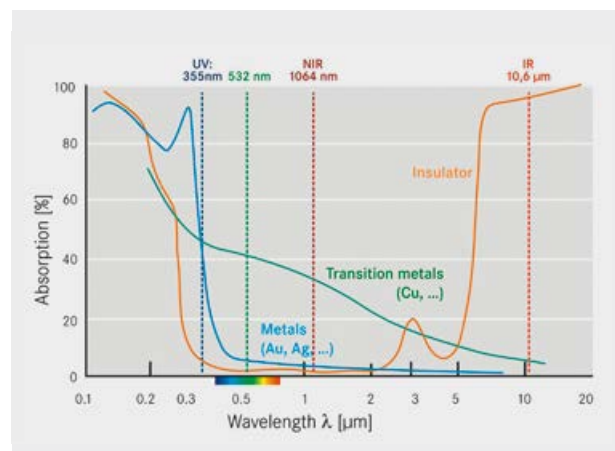

The absorption values vary according to laser wavelength and material

LPKF ProtoLaser S4

The LPKF ProtoLaser S4 stands for efficient prototyping of complex digital and analog circuits as well as RF and microwave PCBs up to a size of 229 mm x 305 mm (9" x 12"). The system can be used for nonlaminated and laminated PCBs. The ProtoLaser S4 structures an A4-sized layout in about 20 minutes.

With a laser source emitting light in the green range of the visible spectrum, this laboratory laser is especially well suited to high-precision PCB processing.

LPKF ProtoLaser U4

The LPKF ProtoLaser U4 is equipped with a UV laser. This laser has a high beam quality and absorption characteristics that make it suitable for numerous tasks.

Due to the specific wavelength of the UV laser, the ProtoLaser U4 can structure, engrave, drill, and depanel a wide variety of materials. This laser system is stable in the low output range and therefore can also be used to process thin layers or organic layers with minimal thermal input.



PCB Structuring with the LPKF ProtoLaser S4

The ProtoLaser S4 is able to laser etch circuit layouts onto PCBs with previously unseen speed and precision. Directly structuring laminated substrates, this compact system can create PCBs with layout dimensions of up to 229 mm x 305 mm (9" x 12"). The LPKF ProtoLaser S4 works in the green range of the visible spectrum (532 nm) allowing for drilling, cutting and laser etching of PCBs without chemicals.



A New Dimension in Prototyping

The ProtoLaser S4 has mastered the two structuring processes of delamination and evaporation, which makes the type of substrate material used largely irrelevant to its operation. The process control allows for processing of copper-coated FR4 material and aluminum-coated PET film alike. Even thermoplastic materials such as PTFE as well as ceramic-filled and pure ceramic substrates used in RF technology are suitable as substrate materials. Trace widths of $\sim 75 \mu\text{m}$ can be generated on laminated materials. With its high precision and edge accuracy, the ProtoLaser S4 provides $\pm 2 \mu\text{m}$ scan field resolution. The reproducibility of results exceeds that of mechanical, tool-based, and chemical processes.

Laser Structuring of Multilayer PCBs

The LPKF ProtoLaser S4 utilizes a patented process for laminated (multilayer) PCBs. The laser first creates the contours of the circuit and delaminates the copper layer. The superfluous copper comes off in planar pieces. In this mode, the ProtoLaser S4 can structure a complex DIN A4-sized pattern layout within 20 minutes.

Laser Structuring of Ceramic Interconnect Devices

For pure ceramic interconnect devices without bonding layers between the conductive material and the substrate, the ProtoLaser S4 uses an alternative method. A high-power laser beam ablates the target material in a fraction of a second with almost zero effect to the ceramic substrate material. Insulation spacing of $15 \mu\text{m}$ and conductor trace widths of $50 \mu\text{m}$ can be realized on these materials.

The LPKF ProtoLaser S4 is suitable even for power electronics applications. Thick-film boards can also be structured through evaporation: the laser beam is passed over a region several times until the conductive layer has been completely removed.

In-House Production on Demand

Challenging applications can be processed from unstructured base materials in minutes with the LPKF ProtoLaser S4.



Cu (18 μm) on FR4



PTFE

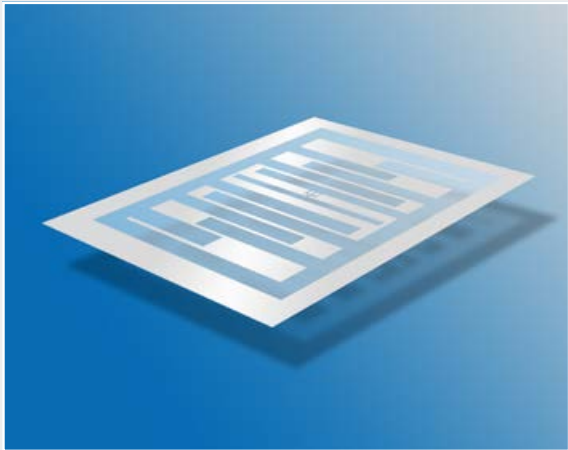

Al (15 μm) on PET film

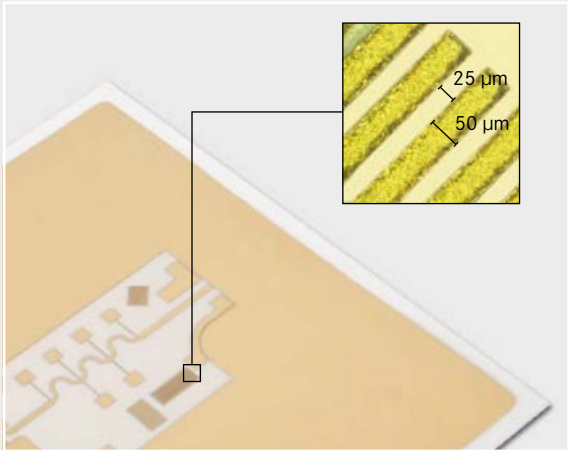

Ceramic

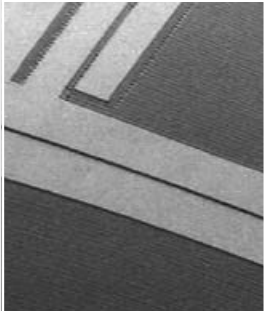
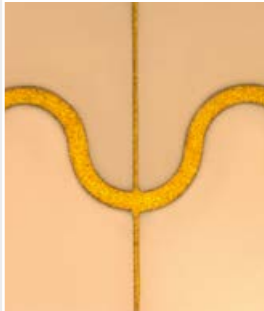

RF structure, Au on Al₂O₃ ceramic

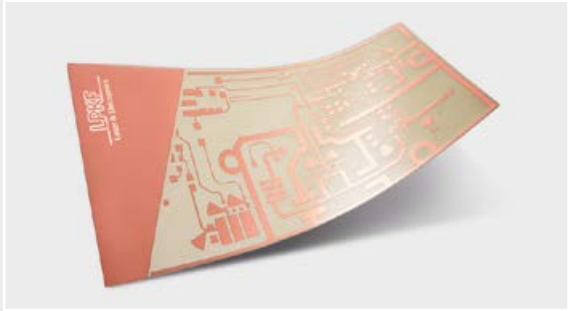

Semiflex material, Cu layer thickness: 18 μm

A Universal Tool: The LPKF ProtoLaser U4

The ProtoLaser U4 is a universal tool for micro material processing. The UV laser system (355 nm) can cut, drill, or laser etch metal on nearly any material. It opens up new paths in prototyping, which were previously too laborious or only possible through external service providers.

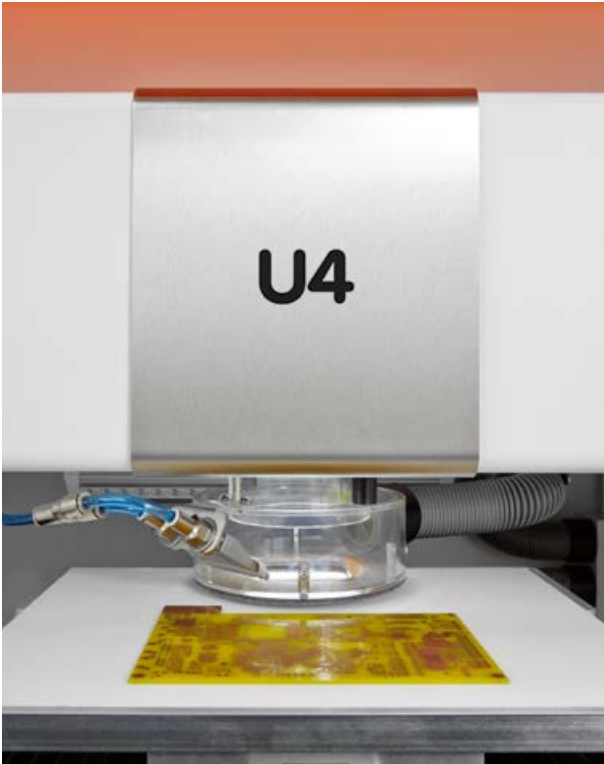

ProtoLaser U4 for Prototyping and Small Batches

The LPKF ProtoLaser U4 is ideal for prototyping and small batch production on demand. It can be used to process various materials rapidly, cleanly, and precisely. The 20 μm UV laser beam can be used for many applications, including precise non-contact depaneling of boards and cutting of LTCCs and prepresses. The ProtoLaser U4 can depanel boards made of numerous different materials: without introducing any stresses, with flexible contours, and for populated or bare boards.

Drilling, Cutting, and Structuring

The ProtoLaser U4 allows for traces as small as 50 μm on laminated PCB materials and even smaller on fired ceramics, can cut holes and microvias to a diameter of just 100 μm in HDI boards. The laser beam pierces

through the copper layer and then the substrate made of epoxy resin and glass fibers.

The LPKF ProtoLaser U4 is also capable of structuring uncommon materials such as TCO/ITO layers. With a precisely controlled output, the laser beam can generate the finest structures with an extremely high accuracy. The UV laser can also cut through solder masks and coverlays.

The low-energy stabilization of the laser extends the processing range to include thin, organic coatings, and the new power measurement on the substrate plane is valuable in the lab: it enables all process data in test series to be recorded precisely.

The ProtoLaser U4 features high repeatability. The optimal position of the laser focal point is set automatically; a camera localizes the workpiece position by means of fiducials. The integrated vacuum table can hold even flexible and thin substrates firmly in place, enabling complex contours to be cut without the material being mechanically loaded.

Parameter Library for Ease and Flexibility

The powerful LPKF CircuitPro CAM software imports existing CAD data and converts them to laser processes. The circuit layout can be changed in a matter of minutes. Process parameters are available for numerous applications. An extensive parameter library provides the settings for the predominant materials – editing of saved projects is easy in user mode. Administrator mode provides full control of all system settings.

Peak Performance in Laser Processing

The UV laser cuts, drills, and structures a wide range of materials.

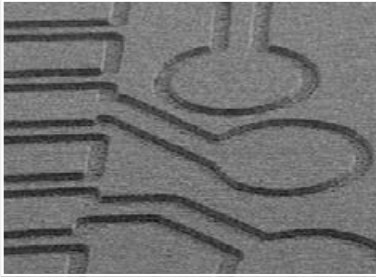

Structuring ultrafine conductors in etch resists (e. g., chemical tin)

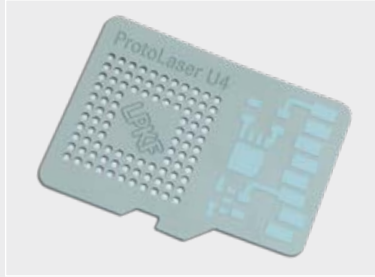

Structuring, engraving, drilling, and depaneling: the ProtoLaser U4 can also be used to process LTCC ceramics



TCO/ITO: invisible traces on transparent materials



Structured and cut-out example of an RF circuit on an RO 5880 material



Laser-structured FR4 boards feature an extremely good match between layout and actual geometry



Cutting populated and unpopulated materials – even into complex shapes: ceramic, polyimide, and FR4

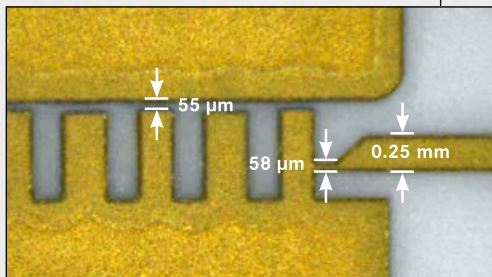
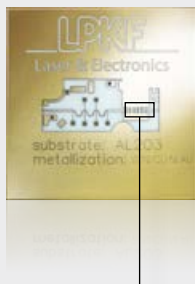
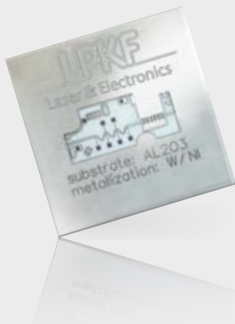

Top results on delicate ceramic materials

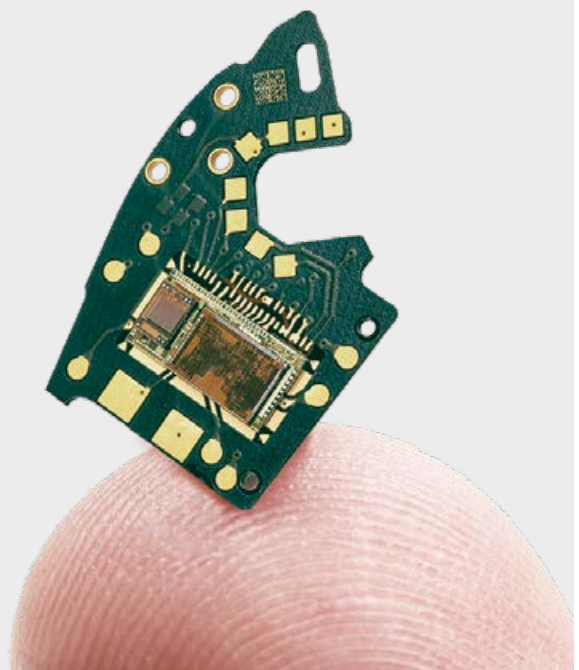

PCB Structuring with the LPKF ProtoMat D104

The LPKF ProtoMat D104 is first and foremost a ProtoMat for mechanical processing of printed circuit board materials, but it is also equipped with a unique tool: a UV laser. This makes the ProtoMat D104 a hybrid between a laser and a circuit board plotter, uniting the possibilities of both tools in a single, low-cost system.

The UV laser in this system is lower power and does not provide rapid delamination as is available on the ProtoLaser models. However the D104 laser is able to produce extremely fine structures by eliminating the need for fine tools with limited service lives. It also offers significantly better precision and can generate geometrically optimized traces. This is important for ultrafine conductor applications as well as digital and RF circuits.

The ProtoLasers can guide the laser beam over the material at high speed thanks to the scanner optical elements. In the ProtoMat D104, the laser track is created through movement of the head and the table without compromising precision.

On ceramic materials, the D104 laser can achieve a trace/space of 50 μm /15 μm (pitch of 65 μm).

The ProtoMat D104 automatically selects the required tools. Each structuring task requiring a finer mechanical resolution than that offered by the installed milling tool is automatically performed using the laser. This applies to structures smaller than 100 μm . However, if there is only a 200- μm milling tool available in the 15-position tool changer, 150- μm structures are also created by the laser. An integrated vision system ensures smooth transitions between the laser lines and the conventionally produced structures with automated fiducial alignment.

Reworking RF Structures

With a special processing routine, the throughput of the LPKF ProtoMat D104 is increased for large, high-precision circuit elements. First the contours of the circuit are generated using the UV laser. Then the larger insulating areas are milled out using conventional milling tools. If necessary, the UV laser can be used for further insulation in tight layouts.

This also applies to sharp angles in the layout. Whereas the radius capability of a milling tool is limited to half the tool diameter, the 15- μm -wide laser beam reaches into the tightest corners.

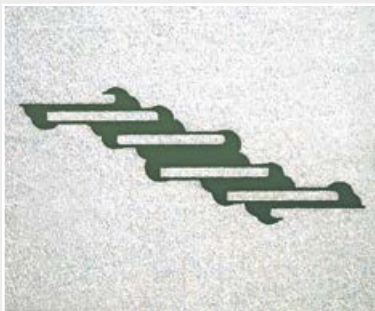

First step: exposure of the fine geometry with the UV laser



Then processing of large surfaces using milling technology (copper rub-out)

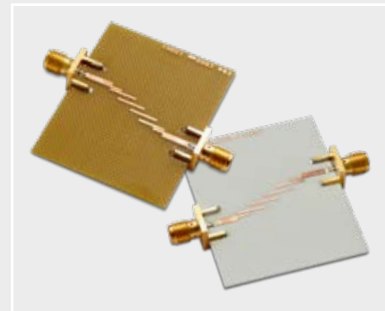

RF filter produced in prototyping

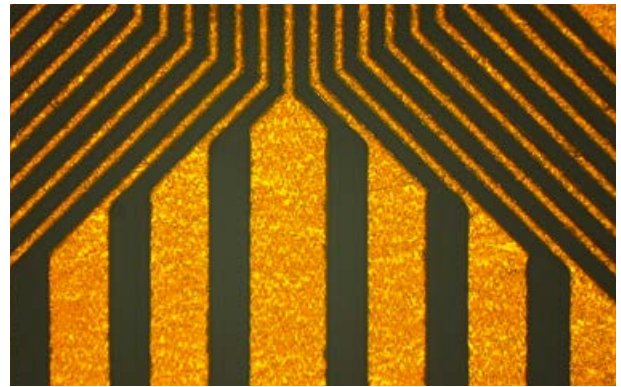
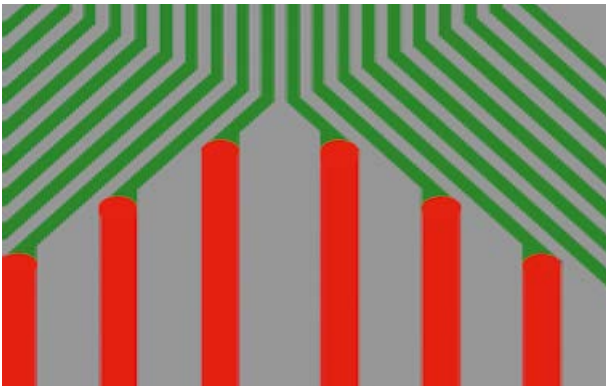

Design and result: The red lines show the milling paths; the green lines represent laser tracks. Tool changeover is performed by the system software.

Overview of Applications

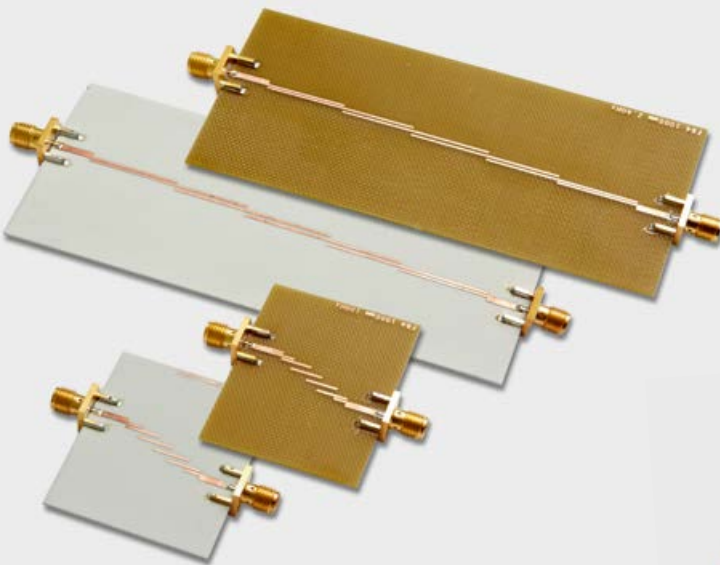

RF filters on various materials, exact geometries through laser processing on the Cu edge

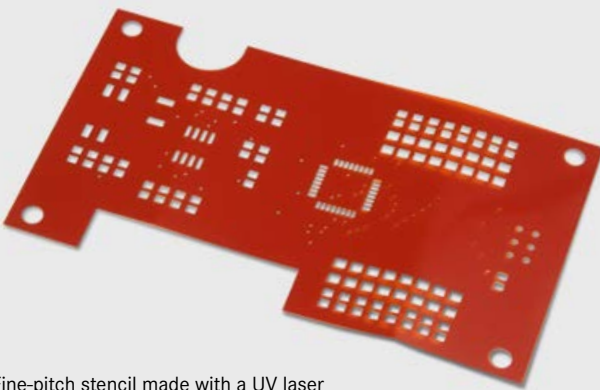

Fine-pitch stencil made with a UV laser for application of solder paste

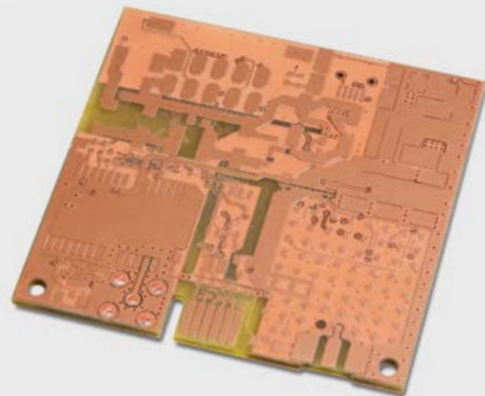

HDI board with ultrafine structures; processing with UV laser and milling/drilling technology

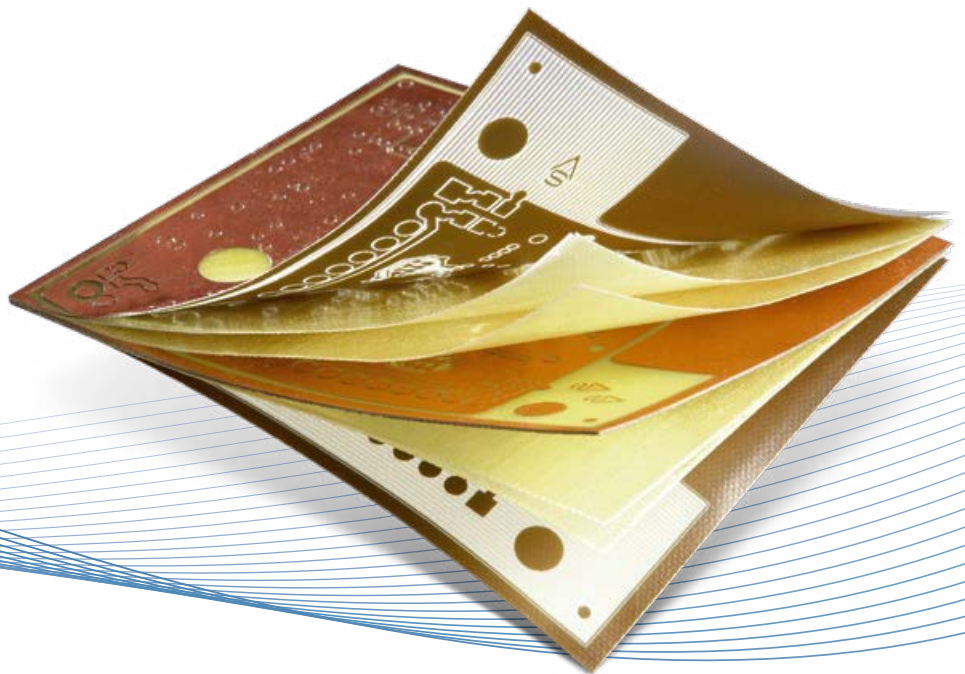

Multilayer Manufacturing and Lamination

Multilayers are printed circuit boards made up of several layers, each exhibiting conductive structures. They are manufactured in three steps: structuring of the individual layers, laminating, and through-hole plating.

One PCB with Several Layers

A multilayer board consists of multiple layers that are bonded to form a single PCB. The outer layers of a multilayer often consist of single-sided PCBs and the inner layers of double-sided material. Insulating layers called “prepregs” are inserted between the conductive layers.

The outer layers, the top layer and the bottom layer are bonded to the inner layers through application of heat and pressure. Pressing plates and pads provide for the optimum pressure distribution in the pressing mold. During lamination the resin in the prepreg melts due to the high temperature and ensures optimum bonding.

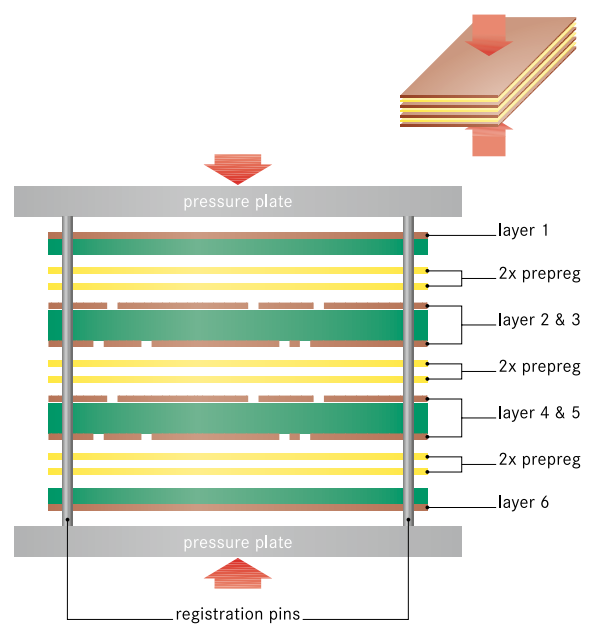
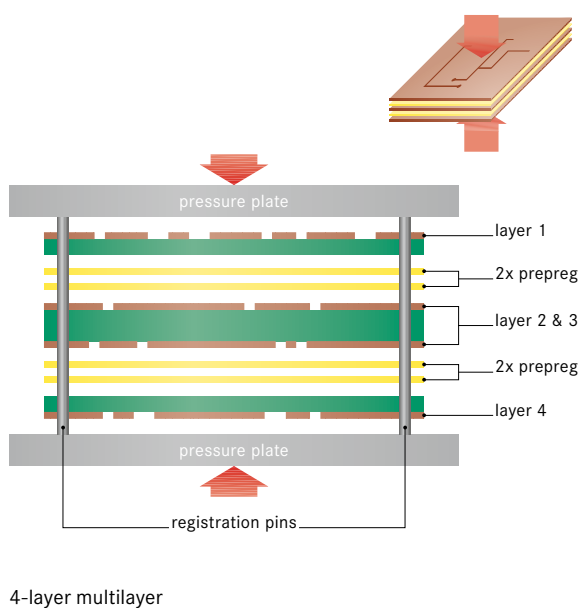

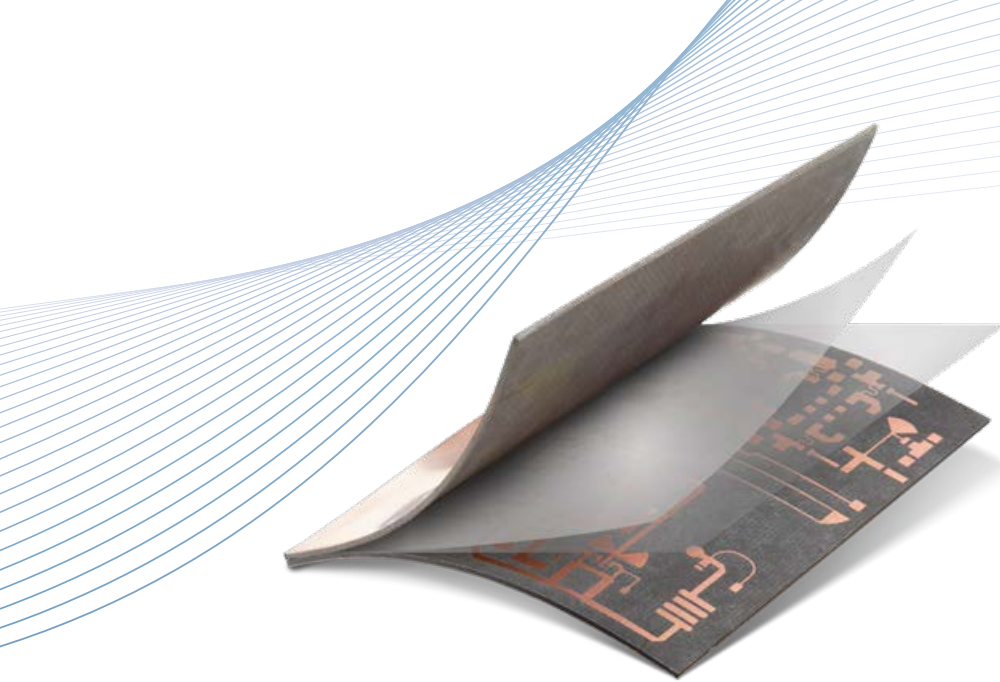

There should not be any air pockets formed during the lamination process. This can be ensured through use of the correct laminating pressure and a suitable temperature profile for the given materials and number of layers. The laminating temperature for a standard multilayer is approx. 180 °C (355 °F). For the LPKF MultiPress S automatic hydraulic press, the multilayers are automatically cycled through the various heating and laminating stages of a process profile.

The type of through-hole plating used impacts the structuring sequence. The outer layers are structured during chemical-free through-hole plating prior to laminating and in through-hole electroplating afterwards. The inner layers of a multilayer must always be structured before laminating.

Eight-Layer Multilayers with the LPKF MultiPress S

The LPKF MultiPress S can laminate up to eight layers from rigid, rigid-flex or flexible substrates. The even pressure distribution across the entire pressing surface of 229 mm x 305 mm (9" x 12") ensures a homogeneous material bond. The LPKF MultiPress S stores up to nine different time, temperature, and pressure profiles, which can be accessed via the menu-guided LCD screen. A number of factory-set standard profiles for common PCB materials are available. Special process profiles can also be used for laminating delicate RF materials, which require a laminating temperature of about 230 °C (445 °F). The LPKF MultiPress S achieves optimal results with fast heating to temperatures of up to 250 °C (490 °F) and short cooling phases.

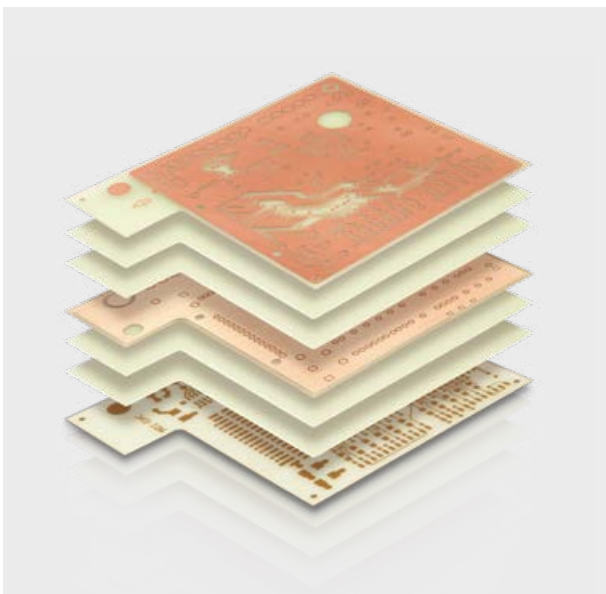

Up to eight layers in-house: LPKF Prototyping



LPKF MultiPress S

Center Punching, Drilling, and Producing Cutouts

A functional double-sided or multilayer PCB requires the drilling of through holes. The drill holes are required for through-hole plating of the individual layers and also serve as holes for registration pins in double-sided structuring or for later mounting of the PCB.



An assortment of tools

Drilling and Center-Punching PCBs

All drill holes on a PCB can be made with LPKF circuit board plotters. Drilling tools with diameters from 0.2 mm to 3 mm are available for this purpose. Drill holes with a diameter larger than 2.4 mm (94 mil) are milled.

The system software LPKF CircuitPro automatically converts these drill holes into milling circles. Drilling parameters such as spindle speed and sinking time, and also the feed rate for spindles with motor-controlled Z-axis, are stored in the software. Additional user intervention is not required.

Very thin or dull drilling tools bring with them the risk of the drill bit slipping and the drill holes being positioned incorrectly. Center punching with a milling tool to tap a hole with a small penetration depth prevents the drill bit from slipping. The 90° tip angle of the 1/8" universal milling cutter, typically used for 200-µm-wide milling grooves, exhibits the optimal geometry for center-punching.

LPKF CircuitPro automatically generates the corresponding production data.

Cutting Out the Board / Contour Milling

With the right milling tools all LPKF circuit board plotters can also be used for contour milling. The PCB is then milled in its entire material thickness. The inner cutouts or contours can be produced with various shapes, including complex shapes. LPKF circuit board plotters can also be used for depaneling – severing tabs of different sizes and shapes.

The choice of milling tool depends on the desired milled width and the material being machined. Milling tools with larger diameters are more stable and can be operated at a higher feed rate. FR4 material is processed with a contour-milling tool. For soft RF base materials or aluminum, a double-edged end mill is used.

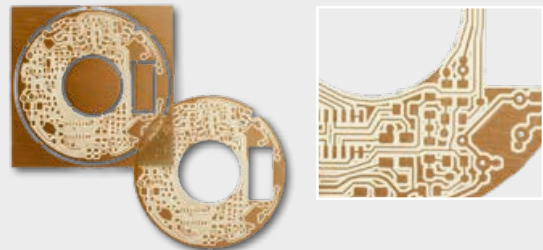

Contour milling and cutouts

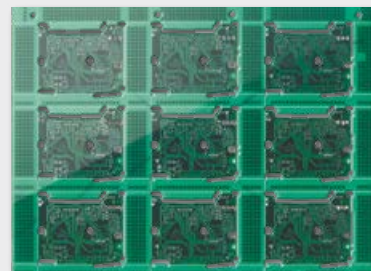

Multipanel



Front panel

Through-Hole Plating Systems

When the circuits of a PCB are distributed over several layers, these layers must be connected. This is done with drill holes that are through-plated with conductive material.

LPKF offers three different through-hole plating systems to suit the respective application:



Manual: LPKF EasyContac



Chemical-free: LPKF ProConduct



Electroplating: LPKF Contac S4

Through-Hole Plating With Rivets

LPKF EasyContac is an easy-to-use system for through-hole plating of standard FR4 double-sided PCBs. The rivet diameter is between 0.6 mm and 1.2 mm (+0.2 mm outer diameter). The system is ideal for PCB prototypes with up to 50 through holes and for repairing PCBs.



Through-hole plating with LPKF ProConduct

Easy to Learn

The rivets are simply placed into the drill holes by hand and inserted with a pressing tool. The rivet is then soldered to the copper layer.

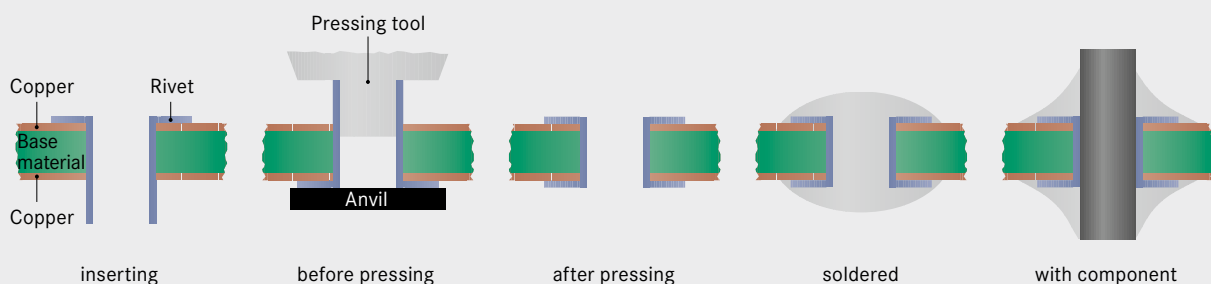

Chemical-Free Through-Hole Plating

LPKF ProConduct is a professional process for prototyping with numerous through holes – with no chemical baths. It is suitable for multilayers with up to four layers and a minimum hole diameter of 0.4 mm at an aspect ratio of up to 1:4.

The maximum size of the PCB is limited solely by the required hot air oven. The contact resistance is approx. 25 mΩ for a hole diameter of 0.4 mm.

Because LPKF ProConduct doesn't apply additional copper to the structured surfaces, they do not impact on the calculations in RF applications.

The outer layers of multilayers are already milled before through-hole plating, due to a more favorable production flow.

LPKF ProConduct: Simple Steps for Through-Hole Plating

1. Protective film:

Apply the self-adhesive special film to the surfaces.



2. Drilling: Use an LPKF circuit board plotter to drill all through holes – through the film.



3. Application of contact paste:

Spread the through-hole contact paste onto the board using a doctor blade.

The vacuum table draws the paste through the holes. Repeat the procedure on the back surface of the board.



4. Curing: Carefully remove the protective film, cure the board in the hot air oven, and clean with ProConduct cleaner under running water.



Fast Temperature Cycling

-40 °C/125 °C (-40 °F/250 °F) @ 1.6 mm (64 mil) FR4 PCB

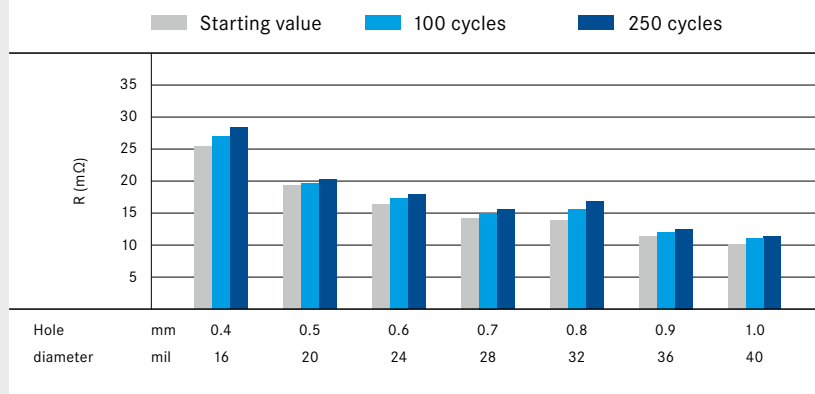

Basis: Double-sided FR4 PCB with 35 μm (1 oz/ft²) copper

The electrical resistance of a plated through hole ranges from 10 mΩ to 25 mΩ. Even after 250 temperature cycles the resistance only exhibits a slight increase (max. 28 mΩ).

Through-Hole Electroplating

Through-hole electroplating is suitable for professional manufacturing of PCB prototypes and small batches. The chemical process corresponds in principle to the process used for mass production. The system can process multilayers with up to eight layers with a minimum hole diameter of 0.2 mm at an aspect ratio of up to 1:10.

In multilayers the outer layers are not milled until after through-hole plating because the entire copper surface on the outer layer is used as a cathode. All inner layers are structured; the drill holes must be made before through-hole plating.

A key characteristic is the equipment used. The LPKF Contac S4 is equipped with six chemical baths for reliable process execution: cleaning baths, an activator bath utilizing the black hole process, a via-cleaning stage, the chemical bath, and a chemical tin-plating bath for improving solderability. The system's glass surface prevents the housing from soiling.

The LPKF Contac S4 is easy to use; no chemical expertise is needed for operation or maintenance. The work process is largely automated. The user is guided step-by-step through all phases by an intuitive menu-driven touch screen.

LPKF Contac S4: Through-Hole Plating in Five Steps

- 1. Cleaning and degreasing:** The PCB is cleaned and degreased in two baths.
- 2. Application of activator:** Following the black hole process, a carbon activator is applied to the surfaces of the drill holes to be plated.
- 3. Via cleaning**
- 4. Galvanization:** The entire LPKF electroplating process is controlled by the system. The user only has to feed in the PCB and enter basic parameters.
- 5. Cleaning:** In the last step, the PCB is cleaned.

The entire process takes about 90 to 120 minutes, depending on the thickness of the copper layer.

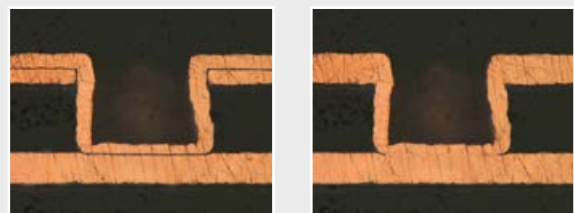

Detached layers from the activation step are reliably eliminated in the via-cleaning step.

Comparison of Through-Hole Plating Methods

LPKF offers three different through-hole plating methods, each of which has its advantages.

The application determines which of the through-hole plating methods is the most suitable. Key data such as the base material size and the layout size are important, but other factors such as special substrates, PCB types, etc. also play a role.

Overview of Methods:

LPKF ProConduct

A versatile manual through-hole plating method without the use of chemical baths. LPKF ProConduct is based on a special through-hole plating paste for rapid and easy coating of drilled holes within minutes.

LPKF Contac S4

Professional through-hole electroplating method utilizing reverse pulse plating. The Contac S4 is a self-contained system that requires no chemical expertise to be operated.

LPKF EasyContac

An easy-to-use manual through-hole plating method for small parts volumes. EasyContac is simple, compact, and portable and hence an ideal entry-level system for through-hole plating of prototypes.

Application	EasyContac	Contac S4	ProConduct
Small production volume, low hole count Although Contac S4 and ProConduct are also ideal for small production volumes and a low number of drill holes (less than 50), EasyContac is the system developed especially for these applications.	•		
Small production volume, high hole count Small production volumes and an unlimited number of through holes can be plated quickly and easily with ProConduct and Contac S4.		•	•
Average production volumes For average production volumes, the Contac S4 through-hole electroplating system is the right choice. The through holes in PCBs of various shapes and sizes can be completely plated.		•	
Difficult surfaces Substrates with special requirements (e.g., pure PTFE).		•	•
RF/microwave PCBs The stringent geometric requirements of RF/microwave PCBs are optimally met with LPKF ProConduct.		•	•
Tin Plating The through-hole electroplating performed by the LPKF Contac S4 includes a "tin plating" option.		•	
Chemical restrictions Wherever use of wet processes is either not possible or only possible to a limited extent, LPKF EasyContac and LPKF ProConduct are suitable. Both methods do without chemical baths.	•		•
High-power circuitry High-power circuits require larger holes and thicker layers. LPKF recommends the Contac S4 for through-hole electroplating for these applications.		•	
Reverse pulse plating The reverse pulse plating process used by the LPKF Contac S4 results in perfectly plated through holes. Reverse pulse plating ensures uniform deposition of copper and prevents accumulation of material or blockage at the drill inlet.		•	

* Possible materials on request

Solder Masks and Legend Printing

The LPKF ProMask solder mask protects surfaces and traces on a PCB. Closely spaced pads are protected from short-circuiting through the professional surface finish provided in the soldering process.

LPKF ProMask is an easy-to-apply green solder mask. The professional surface finish is ideal for SMT prototypes with closely spaced traces.

LPKF ProLegend can be used to apply any information to the PCB – without the use of environmentally harmful wet chemicals.



Applying the Solder Mask in Four Easy Steps

1. Creating the film

template: One film template is required for each side of the board. It is printed onto a transparency with a standard laser printer from LPKF CircuitPro.



2. Applying the solder

mask: The solder mask is mixed from the provided portions of the mask and curing agent components and applied to the entire surface of the board using a foam roller. The board is then predried in the hot air oven at 80 °C (176 °F) for ten minutes.



3. Exposing the board with the film template:

The film template is precisely aligned over the registration marks. The board is then placed in the exposure unit and kept there for 30 seconds. The board is exposed in the regions where the film template is not printed. The film template is removed after the board has been taken out of the exposure unit.



4. Developing and curing the solder mask:

The development bath is prepared through dissolving of the developing powder in warm water. The development bath removes the solder mask from the unexposed regions. Mask residues and water are removed with a brush and water. The solder mask is then cured in the hot air oven for 30 minutes. Oxidation residues are then removed from the board with the LPKF cleaner and rinsed with water.



i The legends are printed in white ink with LPKF ProLegend using exactly the same method. Because the clear areas are later exposed, a film negative must be printed

Solder Paste Printing

Applying solder paste to all pads on which components must be mounted requires maximum precision. The LPKF ProtoPrint S is a manual stencil printer for creating SMT prototypes and small batches.

The mechanical resolution up to a grid dimension of 0.3 mm (12 mil) allows for stencil printing in the ultrafine pitch range. The thickness of the template (between 100 µm and 250 µm) determines the amount of solder paste applied.

The stencil frames can easily be secured with adjustable retaining clips. The freely adjustable holding pins allow the unpopulated side of populated PCBs to be printed. The PCB is accurately aligned in the X and Y position as well as height using micrometer screws. A lever enables parallel lifting of the PCB from the template at a controlled speed. The simple securing of the PCB on a slide allows quick and easy exchange in the production of small batches.

The LPKF solder paste printer is suitable for polyimide stencils – limited to a grid spacing of 0.625 mm (25 mil) at a thickness of 125 µm. Polyimide stencils can be produced with an LPKF circuit board plotter, requiring less time and money than with steel stencils.



LPKF ProtoPrint S

Applying Solder Paste to Board in Six Steps

1. Securing the board:

The board holding pins are mounted on the slide and the board is inserted. Then the film for the test film print is clamped onto the board.

2. Clamping in the stencil:

The slide is moved to print position and the stencil frame is roughly aligned and secured with the retaining clips.

3. Printing a test film

The lever presses the test film against the stencil. Then solder paste is applied evenly to the film using the squeegee and the pad pattern is printed on the film.

4. Fine adjustment:

The test film is released from the stencil with the lever and the slide is moved to the loading position.

The board is aligned precisely to the test film print using the micrometers. Then the test film is cleaned and removed.

5. Applying solder paste:

The slide is moved to the print position and the board is pressed against the stencil with the lever. Then solder paste is applied evenly to the board using the squeegee.

6. Releasing the board:

The board is released from the stencil with the lever. The applied solder paste must remain on the board and not stick to the stencil. The slide is then moved to loading position.

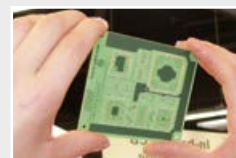

SMD Assembly

Accommodating many functions in a small space requires tiny components. The small size of modern electronic components makes manual assembly of PCBs difficult. With the ProtoPlace S, LPKF offers users a semiautomatic, ergonomic pick & place system for complex SMD assembly.

Semi-Automatic SMD Assembly

SMT boards are assembled in at least three steps. First a vacuum needle removes the SMD component from an antistatic bin or a feeder. Various types of feeders are common: tape-and-reel feeders, stick feeders, or motorized parts turrets. All of these types can be combined with the LPKF ProtoPlace S.

The vacuum needle is mounted to a manipulator, which helps with accurate positioning. The SMD component is manually moved along or rotated about the X-axis and the Y-axis. The optional camera and an LCD color monitor facilitate positioning.

Finally the component is accurately lowered onto the PCB. The adhesion of the solder paste prevents the component from slipping.

For more complex SMD components such as QFPs and PLCCs, the component is roughly positioned before the manipulator is locked in the X-axis, Y-axis, and Z-axis. The PCB can be micro-adjusted under the SMD component with the help of a camera and micrometer screws.

A four-line LCD screen on the LPKF ProtoPlace S guides the user through the individual adjustment and work phases. Virtually all user functions are executed via the four ergonomic arrow keys. The optional camera system with color monitor assists the user in accurately positioning components, even on complex PCBs.



Board assembly

Solder paste, adhesive, or low-viscosity auxiliary materials can be applied with pinpoint accuracy by the integrated standard solder paste dispenser through the proper adjustment of the outlet pressure.

The LPKF ProtoPlace S is optimized for precision assembly of fine-pitch components. The maximum configuration features several feeders, a camera system, and a dispenser.



LPKF ProtoPlace S

Reflow Soldering

Once the PCB is structured and populated only one step remains before it's functional: soldering the components to the conductive pattern. In modern SMT boards, the soldering iron stays cold; a reflow oven connects all soldering points in one step.

Standard and Lead-Free

The compact LPKF ProtoFlow is the ideal oven for reflow soldering of standard as well as RoHS-compliant, lead-free solder, curing of through-hole plating pastes, and other thermal processes requiring precise control. The special "MultiZone" function allows the soldering process to be broken down into five separate phases, each with its own temperature profile. Four internal temperature sensors precisely control the temperature distribution over the entire board. The temperature data from the sensors are displayed on a monitor in temperature-time graphs, which can be saved for later analysis. The LPKF ProtoFlow can process boards with dimensions of up to 229 mm x 305 mm (9" x 12") at a temperature of up to 320 °C.

Inert Gas Option

The LPKF ProtoFlow S/N2 can be externally connected to inert gas with a digital flow controller. The nitrogen atmosphere minimizes oxidation during the soldering process, thus optimizing the solder joint quality.

Factory-set standard reflow profiles are available; additional profiles can be individually programmed and saved.



A lit-up process chamber allows for visual inspection during reflow soldering

The LPKF ProtoFlow can be connected to a computer via a USB interface. The supplied intuitive PC software is used for recording temperature in real time and for programming and saving profiles.

The LPKF ProtoFlow S can be equipped with a sensor module that records changes in temperature over time in up to four freely selectable positions – including on components.



LPKF ProtoFlow S

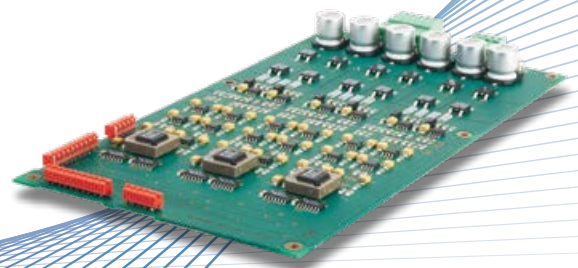

PCB manufactured and assembled using LPKF technology

Applications

From design to completed board: the modular prototyping system from LPKF can realize even complex designs in no time, from structuring to functional PCB.

Flexible and Rigid-Flex PCBs

Flexible and rigid-flex PCBs often cause problems with handling because they can be quite difficult to secure to a work surface. Almost all LPKF structuring systems can be equipped with a vacuum table for securely positioning the PCB, making setup easier, faster, and more accurate.

Because the base material used in flex PCBs is relatively soft, mainly RF tools are used for processing. RF tools have the added advantage of not penetrating the material that deeply. Structuring of a flex PCB is similar to milling of rigid base materials.

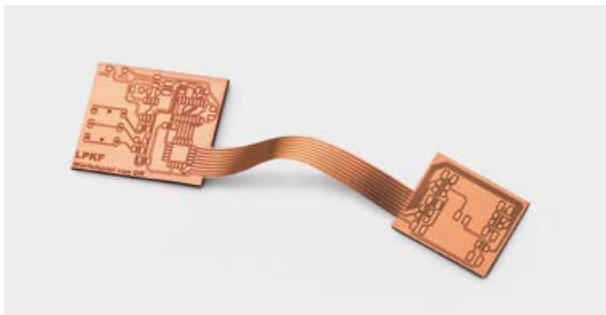
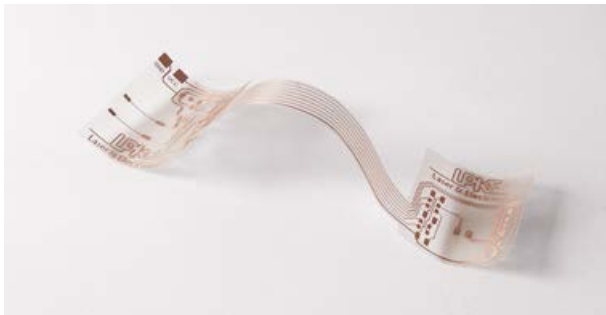

Rigid-flex PCBs combine flexible and rigid PCBs. They are made in a process similar to that used for producing multilayers. One or more rigid sections are structured on a unit. The surface of the area on the unit in which the flexible section is to be inserted remains unstructured and is covered with a barrier sheet. The flexible section is then laminated onto the structured

rigid sections. Afterwards the unstructured section below the flexible PCB is milled off. The same LPKF systems used for producing multilayers can be used here.

Engraving Plastics and Aluminum (2.5 D)

All LPKF circuit board plotters can engrave, drill mounting holes, and mill front plates and almost any type of shapes and lines. Many LPKF circuit board plotters can also be used to drill and mill plastic and soft metals in 2.5 dimensions.



The machining result mainly depends on the spindle speed. LPKF circuit board plotters operated at a speed of at least 60 000 RPM produce very clean milled or cut surfaces. Multiple passes may be required, depending on the milling depth. As a rule of thumb, the milling depth should not be more than half the tool diameter.

The parameter library included in the LPKF CircuitPro software supports the processing of aluminum and other soft materials. The optimum feed rate and the spindle speed for a long tool service life are already saved in LPKF CircuitPro as a standard feature.

RF and Microwave Applications

Producing PCBs for RF and microwave applications is challenging. Materials with special electrical properties are used and must be specially processed. Extremely delicate surfaces often need to be structured. Finally, extremely accurate geometries are often required.

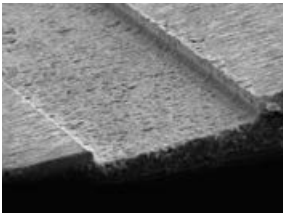

Accurate geometry produced by an RF end mill

Combined with RF tools and a precisely adjustable milling depth, this ensures a clean vertical geometry, even in soft RF base materials. The pneumatic, non-contact depth limiter, which allows the milling head to glide on an air cushion above the base material without physical contact, ensures scratch-free board processing. The LPKF ProtoLasers are unsurpassed in speed and precision. Ultrafine structures and large insulating areas can be rapidly produced – in a non-contact process for soft as well as extremely hard substrate materials.

Milling Stencils

Milling polyimide stencils with LPKF circuit board plotters is a very appealing alternative to steel stencils, particularly from a cost perspective. The solder paste stencils can be milled in-house in less than ten minutes. Generating the milling data in LPKF CircuitPro through inverse isolation is easy. The pad surfaces are not milled around for insulation, but instead milled out.

The advantages of milling polyimide stencils include speed and reliability in the application of solder pastes.

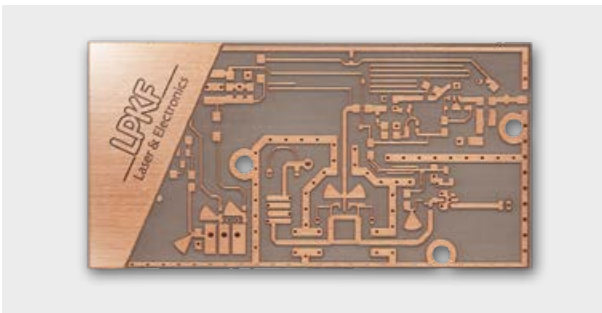

All of these requirements are met with LPKF systems and tools. The LPKF ProtoMat S104 and D104 circuit board plotters feature a maximum spindle speed of 100 000 RPM. The ProtoMat D104 also features a particularly fine laser tool.

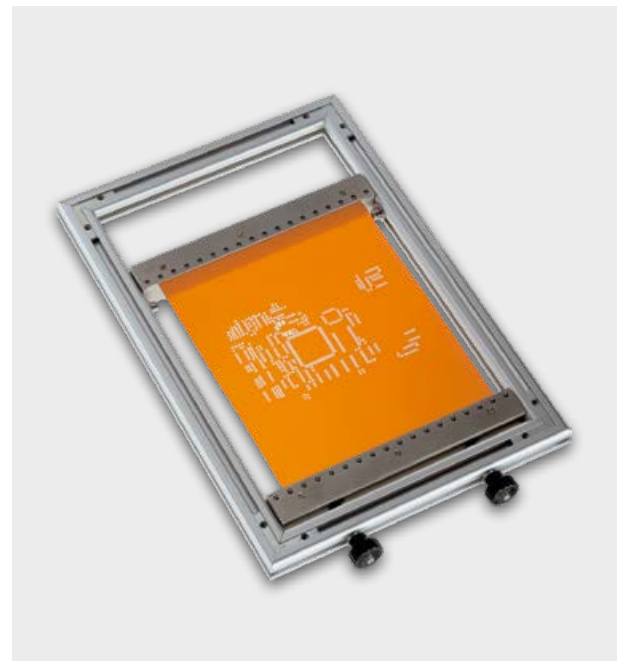

When combined with the LPKF ProtoPrint S SMT stencil printer, stencil printing represents a cost-effective solution for creating the prototype, especially considering the amount of work involved in manual dispensing or soldering.

Depaneling

Depaneling is milling through of breakout tabs holding individual PCBs in a panel. LPKF circuit board plotters are also a good first choice for this. The combination of a vacuum table and optical fiducial detection turns inserting and aligning of a panel into a quick and easy task. The breakout tabs are cut cleanly, providing the user with a PCB with an exact contour.

One especially interesting system is the LPKF ProtoLaser U4. This laser system cuts any contour in thin rigid, rigid-flex, or flexible PCB materials – without mechanically stressing the substrate material or the components.

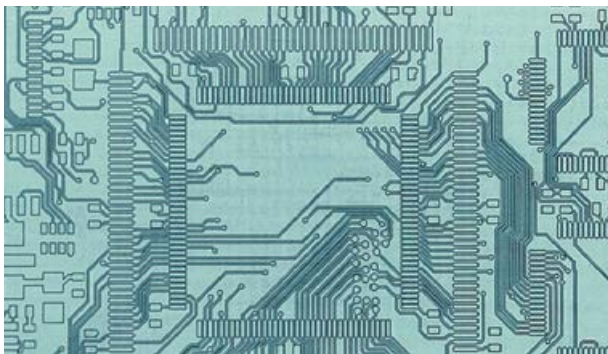
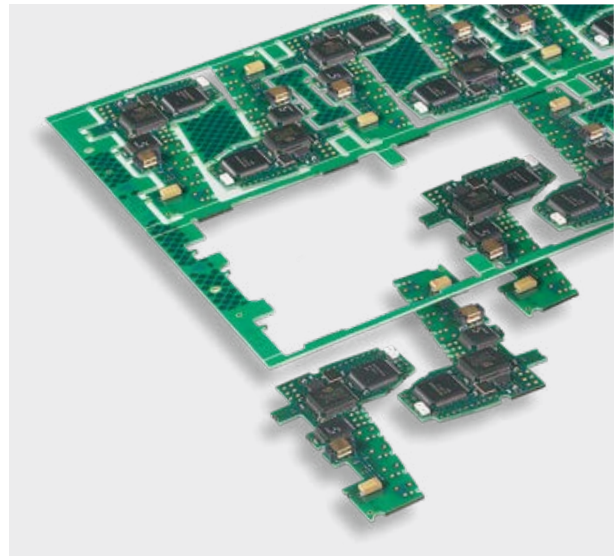

Structuring Ultrafine Conductors

A special application relies on the LPKF ProtoLaser U4 – a combination of laser structuring and etching of the board. The completely copper-clad base material is first chemically plated to produce a homogeneous tin layer. The UV laser beam then removes the tin resist in the areas in which etching should occur. With this technique, ultrafine conductor regions for conductive trace width and spacing $< 50 \mu\text{m}$ can be produced.

Milling Block Materials

The LPKF ProtoMats with Z-axis control not only can process PCB materials but also can be used to manufacture thin brackets and shaped parts. LPKF has two certified plastic block materials that exhibit high strength and low weight and are easy to process by milling.



Dispensing

The dispensers introduced with the ProtoMat-S series apply low-viscosity auxiliary materials such as solder pastes to the board with pinpoint accuracy.

Technical Terms

A

Activation

Treatment that enables electroless deposition on a nonconductive material. Also: activation of embedded additives in plastic or paint in the laser direct structuring process.

Annular Ring

The conductive foil and plating surrounding a hole.

Aperture

A description of the shape and size of the tool used to create a pad or track. The term comes from the days of vector photoplotters, where film was exposed by shining light through apertures (shaped holes) arrayed around the edge of a disk (or "aperture wheel"). Each aperture corresponded to a different D code in the Gerber data. Today, photoplotters use lasers to expose the film but the term "aperture" persists.

Aperture List

A list of the shapes and sizes for describing the pads and tracks used to create a layer of a circuit board.

Artwork

A phototool used to create the different layers during printed circuit board manufacture.

Artwork Master

An accurately scaled (usually 1:1) pattern which is used to produce the production master.

Aspect Ratio

The ratio of the circuit board thickness to the smallest hole diameter.

B

B-Stage Material

Sheet material impregnated with a resin cured to an intermediate stage (B- stage resin). The preferred term is prepreg.

Backplanes and Panels

Interconnection panels into or onto which printed circuits, other panels, or integrated circuit packages can be plugged or mounted.

Bare Board

A finished PCB without added components.

Barrel

The cylinder formed by plating through a drilled hole.

Base Laminate or Base Material

The substrate material upon which the conductive pattern is formed. The base material can be rigid or flexible.

"Bed-of-Nails"

A method of testing printed circuit boards that employs a test fixture mounting an array of contact pins configured so as to engage plated-through holes on the board.

Blind Via

A via hole that does not pass completely through the printed circuit board. A blind via starts from one side or another.

Bond Strength

The force per unit area required to separate two adjacent layers of a board by a force perpendicular to the board surface.

Bridging

A buildup of solder between tracks or pads causing a short circuit.

Buried Via

A mechanically or laser drilled hole which interconnects internal layers only. It is not electrically connected to any external layer.

C

C-Stage

The condition of a resin polymer while in a solid state, with high molecular weight, being insoluble and infusible.

Center-To-Center Spacing

The nominal distance between the centers of adjacent features or traces on any layer of a printed circuit board.

Chamfer

A corner which has been rounded or angled to eliminate an otherwise sharp edge.

Circuit

The interconnection of a number of devices in one or more closed paths to perform a desired electrical or electronic function.

Circuit Layer

A layer of a printed board containing conductors, including ground and voltage planes.

Clad or Cladding

A relatively thin layer or sheet of metal foil which is bonded to a laminate core to form the base material for printed circuits.

Clearance Hole

A hole in the conductive pattern larger than, but concentric with, a hole in the base material of the PCB.

Coefficient of Expansion, Thermal

A material's fractional change in dimension for a unit of temperature fluctuation.

Component Hole

A hole used for attachment and electrical connection of component terminations, including pins and wires, to the printed circuit board.

Component Side

The side of the printed circuit board on which most of the components are mounted.

Conductive Pattern

The configuration or design of the conductive material on the base laminate. Includes conductors, lands, and through-hole plating.

Conductor Base Width

The conductor width at the base material's surface plane. See also: Conductor Width

Conductor-To-Hole Spacing

The distance between the edge of a conductor and the edge of a supported or unsupported hole.

Conductor Spacing

The distance between tracks on a printed circuit board.

Conductor Width

The perceivable width of the respective conductor in any random PCB location.

Controlled Impedance

The process that gives a circuit the correct impedance value. The design engineer will specify the track impedance required. From this, a suitable manufacturing build will be chosen for the track widths and layer spacings on the design to meet the required impedance.

Copper Foil

A cathode-quality electrolytic copper used as a conductor for printed circuits. Available in a number of weights (thicknesses); the traditional weights are 1 and 2 ounces per square foot (0.0014 and 0.0028 inches thick).

Current-Carrying Capacity

The maximum current which can be carried continuously, under specified conditions, by a conductor without degrading the electrical or mechanical properties of the printed circuit board.

D**Datum Reference**

A defined point, line, or plane used to locate the pattern or layer for manufacturing, inspection, or for both purposes.

Deburring

Process of removing a burr after drilling the board. There are two types of deburring: producing a clean, sharp edge when removing heavy burr; and rounding the edges of holes to prevent build-up during plating.

Design Rules Check

A computer aided program used to check the manufacturability of the circuit board. The checks include track to track gaps, track to pad gaps, annular ring sizes, track to board edge gaps, acid trap detection, unterminated track checks.

DFM

Design For Manufacture.

Dielectric

An insulating medium which occupies the region between two conductors.

Dielectric Constant

That property of a dielectric that determines the electrostatic energy per unit volume for unit potential grade.

Digitizing

Any method of reducing feature locations on a flat plane to digital representation in X-Y coordinates.

Dimensional Stability

A measure of dimensional change caused by factors such as temperature, humidity, chemical treatment, age, or stress; usually expressed as units/unit.

Double-Sided Board

A printed board with a conductive pattern on both sides, but no inner layers.

Drill Table

A description of the drill sizes used to create the circuit board. The drill equivalent of an aperture list.

E**Edge Connector**

The portion of the PCB used to provide external electrical connection, normally gold plated.

Electroplating

The electrodeposition of a metal coating onto a conductive object. The object to be plated is placed in an electrolyte and connected to one terminal of a D/C voltage source. The metal to be deposited is similarly immersed and connected to the other terminal. Ions from the metal provide transfer to metal as they make up the current flow between the electrodes.

Etching

The process of removing unwanted metallic substance (bonded to a base) using chemicals, or chemicals and electrolytes.

F**Fiducial**

A feature of the printed circuit board used to provide a common measurement point for all steps in the assembly process.

Flash

A pad. Another term dating from the days of vector photoplotters – tracks were drawn, pads were “flushed”. See also pad. “Flash” is also a term used to describe excess material squeezed out between mold pieces during a casting.

Flux

A substance used to promote or facilitate fusion, such as a material used to remove oxides from surfaces to be joined by soldering or welding.

Foil

A thin sheet of metal, usually copper or aluminum, used as the conductor for printed circuits. The thinner the foil, the lower the required etching time. Thinner foils also permit finer definition and spacing. See Copper Foil.

FR4

The standard glass epoxy substrate.

Fused Coating

A metallic coating (usually tin or solder alloy) which has been melted and solidified forming a metallurgical bond to the base material.

G**Gerber Data**

A type of data consisting of graphics commands, usually describing how to draw a picture of a circuit. Intended for directing a photoplotter, it is the most common format for data transfer from PCB CAD systems to the manufacturing process. Gerber data is officially designated as RS-274-D (without embedded aperture codes) and RS-274-X (with embedded aperture codes).

Ground Plane

A conductor layer, or portion of a conductor layer, used as a common reference point for circuit returns, shielding, or heat sinking.

H**HP-GL™**

Hewlett Packard Graphics Language.

I**Internal Layer or Inner Layer**

A conductive pattern which is contained entirely within a multilayer printed board.

IR laser

Laser system working in the infrared range. The LPKF ProtoLaser S uses a laser source with a wavelength of 1064 nm.

L

Laminate

A product made by bonding together two or more layers of material.

Lamination

The process of preparing a laminate; or a multilayer PWB.

Land

A portion of a conductive pattern usually, but not exclusively, used for the connection and/or attachment of components. Also called Pad, Boss, Terminal area, Blivet, Tab, Spot, or Donut.

Layer-To-Layer Spacing

The thickness of dielectric material between adjacent layers of conductive circuitry in a multilayer printed circuit board.

Legend

A format of lettering or symbols on the printed board; e.g. part number, component locations, and patterns.

LDS

Laser Direct Structuring. The laser beam writes conductor structures on an additive-containing plastic component. It activates the additive in the plastic, leaving a microrough surface for metallization.

M

Mask

A material applied to enable selective etching, plating, or the application of solder to a printed circuit board.

Metallization

Buildup of traces in the LDS process: In a chemical metallization bath, copper and other metals accumulate on a seed layer on a structured plastic component. The conductor layer is formed out of this. In contrast to galvanic metallization, no voltage is applied.

Microsectioning

The preparation of a specimen for the microscopic examination of the material to be examined, usually by cutting out a cross-section, followed by encapsulation, polishing, etching, staining, etc.

Mil

1/1000th of one inch, or 0.001".

Minimum Annular Ring

The minimum metal width, at the narrowest point, between the circumference of the hole and the outer circumference of the land. This measurement is made to the drilled hole on internal layers of multilayer printed circuit boards and to the edge of the plating on outside layers of multilayer boards and double-sided boards.

Minimum Electrical Spacing

The minimum allowable distance between adjacent conductors sufficient to prevent dielectric breakdown, corona, or both, between the conductors at any given voltage and altitude.

Misregistration

The lack of conformity between two or more patterns or features.

Mixed Technology

Describes the assembly process of using pin through-hole, surface mount, and other mounting technologies on the same printed circuit board.

Multilayer Printed Circuit Boards

Printed circuit boards consisting of three or more conducting circuit planes separated by insulating material and bonded together with internal and external connections to each level of the circuitry as required.

N

Nick

A cut or notch in a track or pad.

O

Open

A loss of electrical continuity caused by a break in a track.

P

Pad

The portion of the conductive pattern on printed circuits designated for mounting or attaching components. Also called Land.

Panel

The base material containing one or more circuit patterns that passes successively through the production sequence and from which printed circuit boards are extracted. See Backplanes and Panels.

Panel Plating

The plating of the entire surface of a panel (including holes).

Pattern Plating

Selective plating of a conductive pattern (including holes).

PCB

Printed Circuit Board

Photo Plot

A high accuracy laser plotting system. It is used to produce actual size master patterns for printed circuit artwork directly on dimensionally-stable, high contrast silver halide photographic film.

Photoplotter

A device for generating photographic images by directing a controlled-light beam that directly exposes a light-sensitive material.

Photoresist

A light sensitive liquid or a film which, when selectively exposed to light, masks off areas of the design that can then be etched away.

Plated-Through Hole (PTH)

A hole used to form the electrical connections between layers. This is achieved by metalizing the walls of the hole.

Plating, Electroless

See Plating.

Plating, Electrolytic

See Plating.

Plating Resists

Materials which, when deposited on conductive areas, prevent the plating of the covered areas. Resists are available both as screened-on materials and as dry-film photopolymer resists.

Plotting

The mechanical conversion of X-Y positional information into a visual pattern, such as artwork.

Polyimide Resins

High temperature thermoplastics used with glass to produce printed circuit laminates for Multilayer and other circuit applications requiring high temperature performance.

Prepreg

Sheet material consisting of the base material impregnated with a synthetic resin, such as epoxy or polyimide, partially cured to the B-stage.

PWT

Printed Wiring Technologies

R**Reflowing**

The melting of an electro-deposit followed by solidification. The surface has the appearance and physical characteristics of being hot-dipped.

Registration

The degree of conformity of the position of a pattern, or a portion thereof, with its intended position or with that of any other conductor layer of a board.

Resist

Coating material used to mask or to protect selected areas of a pattern from the action of an etchant, solder, or plating. Also see: Dry-Film Resists, Plating Resists and Solder Resists.

Router

A machine that cuts away portions of the laminate to leave the desired shape and size of a printed circuit board.

S**Schematic Diagram**

A drawing which shows, by means of graphic symbols, the electrical connections, components and functions of an electronic circuit.

Scoring (V-Scoring)

The panels are precision cut through both sides of the panel to a preset depth. The panels remain rigid for assembly but are ready for breaking into individual circuits.

Screen Printing

A process for transferring an image to a surface by forcing suitable media through a stencil screen with a squeegee. Also called Silk Screening.

Single Sided Board

A printed circuit board that contains tracks and pads on one side of the board and no plating in the through holes.

SMT

Surface Mount Technology

Solder Leveling

The process of dipping printed circuit boards into molten solder and leveling the surface with hot air.

Solder Mask or Resist

Coatings which mask and insulate portions of a circuit pattern where solder is not desired.

Solder Side

On printed circuit boards with components on only one side, the side of the PCB that is opposite to the component side.

Surface Mounted Technology (SMT)

The components are mounted on the surface of a circuit board rather than inserting components into plated through-holes.

T**Tester**

A device that checks a PCB for the connectivity of its circuits from the design netlist.

Thin Foil

A metal sheet less than 0.0007 inches (1/2 oz) thick or less.

Tooling Holes

The general term for non-plated holes placed on a printed circuit board or a panel used for registration and tooling during manufacturing, testing and assembly.

Track

An electrical connection between two or more points on a PCB.

U**UL (Underwriters Laboratory)**

A U.S. safety standard certification organization.

UV (Ultraviolet)

Ultraviolet radiation is electromagnetic waves with short wave length which can be used for curing polymers. Ultrasonic waves can also be used to clean PCBs in special cleaning equipment.

UV laser

Laser system working in the ultraviolet range. These wavelengths are easily absorbed by numerous materials.

V**Via or Via Hole**

A plated-through hole used to connect individual layers of a circuit board. These holes are generally the smallest as no components are inserted in them.

ViaCleaner

A special bath that removes activator coatings from copper surfaces in microvias prior to galvanic via plating.

W**WYSIWYG**

What You See Is What You Get. This term describes a computer interface that reflects an actual physical object, as opposed to a more symbolic representation. For example, early word processing programs produced a final printed output that was very different to what appeared on the editing screen, but later programs appeared on the editing screen exactly as they were expected to print

LPKF International Contacts

Australia

Embedded Logic Solutions Pty. Ltd.
Phone +61-2-96871880
Fax +61-2-96871881
sales@emlogic.com.au
www.emlogic.com.au

Austria

elsinger electronic handel gmbh
Phone +43-1-9794651-0
Fax +43-1-9794651-24
office@elsinger.at
www.elsinger.at

Brazil, Argentina, Chile, Colombia

ANACOM Electronica Ltda.
Phone +55-11-3422-4200
Fax +55-11-3422-4242
contato@anacom.com.br
www.anacom.com.br

Czech Republic

SE Spezial-Electronic AG, o.s.
Phone +420-233-326621
Fax +420-233-326623
spezial@spezial.cz
www.spezial.cz

China

LPKF (Tianjin) Co., Ltd.
Phone +86-22-2378-5318
sales.china@lpkf.com
www.lpkf.cn

Egypt

Universal Advanced Systems (UAS)
Phone +20-2-24030660
Fax +20-2-24027629
mahmoud.aladdin@uas-eg.com
www.uas.com.eg

Finland

IsoProto Oy
Phone +358 50 381 3344
janne.isopahkala@isoproto.fi
www.isoproto.fi

France

Inoveos S.A.R.L.
Phone +33-587498020
Fax +33-587498021
oseguin@inoveos.com
www.inoveos.com

Great Britain

TRACKS Laser & Electronics Ltd.
Phone +44-844-8157266
Fax +44-844-5763855
s.curran@trackslaser.co.uk
www.trackslaser.co.uk

Greece

S.K.T. Testing Co.
Phone +30-210-6618414
Fax +30-210-6618421
ktheodoridis@skt-testing.gr
www.skt-testing.gr

India

Bergen Associates Pvt. Ltd.
Phone +91-11-2592-0283
Fax +91-11-2592-0289; -0292
info@bergengroupindia.com
www.bergengroupindia.com

Israel

MTI SUMMIT Engineering Ltd.
Phone +972-3-9008900
Fax +972-3-9008902
adip@mtisummit.co.il
www.mtisummit.co.il

Italy

NITZ engineering GmbH
Phone +39-0472-833944
Fax +39-0472-833943
info@nitz.it
www.nitz.it

Japan

LPKF Laser & Electronics K.K.
Phone +81 47 432-5100
Fax +81 47 432-5104
info.japan@lpkf.com
www.lpkf.jp

Jordan

International Engineers for Trading
Phone +962-6-551-4648
Fax +962-6-551-9211
ie-est@nol.com.jo
www.ie-est.com.jo

Pakistan

Zeeshan Electronics
Phone +92-51-4449945
Fax +92-51-4449948
zia.sheikh@zeeshanelectronics.com

Peru

MBC Representations S.A.C.
Phone +51-1-296-8889
mariaburgos@speedy.com.pe
www.mbc.pe

Poland

SE Spezial-Electronic Sp.z.o.o.
Phone +48-228409110
Fax +48-228412010
marek@spezial.pl
www.spezial.pl

Romania

Interbusiness Promotion
& Consulting S.R.L.
Phone +40 31 4178390
Fax +40 31 4178390
marian.lazurca@interbusiness.ro
www.interbusiness.ro

Russia

OOO All Impex 2001
Phone +7-495-9213012
Fax +7-495-646-20-92
info@all-impex.ru
www.all-impex.ru

SE Spezial-Electronic Moscow

Phone +7-095-438-7343
Fax +7-499-737-5108
info@spezial.ru
www.spezial.ru

Saudi Arabia

ARAB ENGINEERS for
Trading Co., Ltd.
Phone +966-1-4633117
Fax +966-1-4652766
tdegwy@ae.com.sa
www.ae.com.sa

Singapore

HAKKO Products Pte. Ltd
Phone +65-67482277
Fax +65-67440033
sales@hakko.com.sg
www.hakko.com.sg

Slovenia, Croatia, Serbia

Amtest d.o.o.
Phone +385-1-3908500
Fax +385-1-3908509
mitja.zupan@amtest-smt.com
www.amtest-smt.com

South Africa

Cadshop Pty. Ltd.
Phone +27-823770052
Fax +27-866188782
davidpower@vodamail.co.za
www.cadshop.co.za

South Korea

LPKF Korea Laser & Electronics Ltd.
Phone +82-31-689-3660
Fax +82-31-478-5988
sales.korea@lpkf.com
www.lpkf.kr

Sweden

SOLECTRO AB
Phone +46-40-536-600
Fax +46-40-536-610
Solectro@Solectro.se
www.solectro.se

Switzerland

Lumatron AG
Phone +41-62-7977580
Fax +41-62-7977581
h.kurth@lumatron.ch
www.lumatron.ch

Taiwan R.O.C.

Li Huey Co. Ltd.
Phone +886-2-22405585
Fax +886-2-22405285
kevin@lihuey.com
www.lihuey.com

Microsys Engineering Co., Ltd.

Phone +886-3-222-3170
Fax +886-3-222-3150
microsys@ms7.hinet.net
www.microsys-e.com.tw

The Netherlands

Tooltronics
Phone +31-88-2916652
Fax +31-88-2916652
rob.bruin@tooltronics.nl
www.tooltronics.nl

Turkey

TAMARA Elektronik Müh. Ltd. Sti.
Phone +90-2164189294
Fax +90-2164189396
tamara@tamara.com.tr
www.tamara.com.tr

GZ Elektronik Ltd.

Phone +90-312 214 1400
Fax +90-312-214 1401
info@gz.com.tr
www.gz.com.tr

Ukraine

SPF VD MAIS
Phone +380-44-2200101
Fax +380-44-2200202
v.linskiy@vdm.kiev.ua
www.vdm.kiev.ua

USA

LPKF Distribution Inc.
Phone +1-503-454-4200
Fax +1-503-682-7151
info@lpkfusa.com
www.lpkfusa.com

Venezuela

Inversiones Makarelli, C.A.
Phone +58-212-985-4822
Fax +58-212-256-1521
inversionesmakarelli@gmail.com

Vietnam

TECAPRO Co.
Phone +84-4-62637202
Fax +84-4-38458032
hoanganhtec@hn.vnn.vn



Legal Information

Price Lists

Any price lists inserted into the catalog or supplied with the catalog are not part of the catalog. All prices are subject to change without notice. Please contact LPKF or an LPKF distributor for the latest offers.

Disclaimer

Errors and omissions excepted. Specifications subject to change without notice. The information that LPKF provides in this catalog has been compiled with great care. Although every effort has been made to ensure its accuracy, errors cannot be completely ruled out. LPKF Laser & Electronics AG does not accept any liability for or provide any guarantee of the correctness, accuracy, or completeness of the information provided herein. LPKF reserves the right to change or supplement the information and data provided without prior notice.

Copyright, Trademark, and Patent Information

© 2018 LPKF Laser & Electronics AG, Garbsen, Germany. All rights reserved. The contents of this catalog, including images and the catalog design, are protected by copyright and other laws to protect intellectual property. The systems and products of LPKF and their subsidiaries are protected by the applicable German laws and, in some cases, international patents. Product and trade names mentioned in the product catalog are, in some cases, registered trademarks of the respective manufacturers. The LPKF logo, "LPKF ProtoMat," "LPKF ProConduct," "CircuitPro," "ProMask," "Allegro," and "SolarQuipment" are registered trademarks of LPKF Laser & Electronics AG.

LPKF Laser & Electronics AG
Osteriede 7
30827 Garbsen
Deutschland

Service

LPKF circuit board plotters and laser systems deliver outstanding performance in laboratories and development departments around the world. More than 50 branch offices and distributors are available to ensure seamless services and provide support and advice.



The global LPKF network for service and distribution:

- Headquarters
- LPKF Group
- LPKF Distributors

LPKF Laser & Electronics AG sells and markets products and provides support in more than 50 countries. Find your local representative at www.lpkf.com.

Worldwide (LPKF Headquarters)

LPKF Laser & Electronics AG Osteriede 7 30827 Garbsen Germany
Phone +49 (5131) 7095-0 info@lpkf.com www.lpkf.com

North / Central America

LPKF Laser & Electronics North America
Phone +1 (503) 454-4200 sales@lpkfusa.com www.lpkfusa.com

China

LPKF Tianjin Co., Ltd.
Phone +86 (22) 2378-5318 sales.china@lpkf.com www.lpkf.com

Japan

LPKF Laser & Electronics K.K. Japan
Phone +81 (0) 3 5439 5906 info.japan@lpkf.com www.lpkf.com

South Korea

LPKF Laser & Electronics Korea Ltd.
Phone +82 (31) 689 3660 info.korea@lpkf.com www.lpkf.com



LPKF Service & Support
LPKF provides worldwide premium customer support. Learn more:
www.lpkf.com/support

